



HUNTER MARINE CORPORATION
ROUTE 441, POST OFFICE BOX 1030
ALACHUA, FLORIDA 32616
Tel: (386) 462-3077
Fax: (386) 462-4077
E-MAIL: info@huntermarine.com

HUNTER OWNER'S MANUAL

TABLE OF CONTENTS

<i>INTRODUCTION PAGE</i>	<i>PAGE</i>
• Table of Contents	i
• Welcome to The Hunter Marine Family.....	1
• Hunter Warranty.....	2-8
• Brief History.....	9
• Glossary of Sailing Terms.....	10-13
• Float Plan.....	14
• Explanation of Safety Precautions.....	15
• Safe Boating Tips.....	16-1 ~16-2
• Launch & Retrieving Procedures.....	17
• General Care.....	18 -19
• Lighting Warning.....	20
• Advanced Composite Process	21

About Your Hunter JY15

• Dimensions and Capacities.....	22
• Mainsheet Purchase Details.....	23
• Boom Vang Details.....	23
• Standing Rigging (Forestay & Furling Details).....	24
• Centerboard Assembly.....	25
• Centerboard Details.....	26
• Rudder & Tiller Details.....	27
• Standard Forestay Standing Rigging.....	28
• JY15 Standing & Running Rigging Specifications.....	29
• JY15 Rigging Instructions.....	30-46

Welcome to
THE HUNTER MARINE FAMILY

Congratulations on your new sailing yacht manufactured by Hunter Marine. We have engineered and constructed your boat to be as fine a yacht as any afloat. In order to get the best performance and most enjoyment from your boat you should be familiar with its various elements and their functions. For your sailing pleasure and safety, please take time to study this manual.

We stand behind the quality of your boat with a warranty, which you should review. To insure the validity of your warranty, please complete the attached card and send it to us within ten (10) days of the purchase date. Section 15 of the U.S. Federal Boat Safety Act requires registration of a boat's first owner. The warranty data should also be recorded in the space below for your own reference.

This manual has been compiled to help you operate your craft with safety and pleasure. It

contains details of the craft; equipment supplied or fitted, systems, and information on operation and maintenance. Please read it carefully, and familiarize yourself with the craft before using it. If this is your first sailboat or you are changing to a type of craft you are not familiar with, please ensure that you obtain proper handling and operating experience before you assume command of the craft. Your dealer or national sailing federation or yacht club will be pleased to advise you of local sea schools or competent instructors.

PLEASE KEEP THIS MANUAL IN A SAFE PLACE AND HAND IT OVER TO THE NEW OWNER IF YOU SELL THE CRAFT.

You should also complete the warranty cards for your engine and other accessories. These are enclosed in the manufacturers' manuals that are packaged with your owner's manual.

OWNER INFORMATION CARD

HULL IDENTIFICATION NUMBER IS ON THE STARBOARD AFT SIDE OF THE HULL OR TRANSOM. THIS NUMBER MUST BE GIVEN IN ALL NECESSARY CORRESPONDENCE.

HULL NO.

DATE DELIVERED TO OWNER

YACHT NAME

OWNER NAME

STREET ADDRESS

CITY

STATE/COUNTRY

ZIP CODE

HOME PORT

ENGINE MODEL

SERIAL NO.

PROPELLER SIZE

DEALER

PHONE

STREET ADDRESS

CITY

STATE/COUNTRY

ZIP CODE



HUNTER®
MARINE CORPORATION
AN EMPLOYEE OWNERSHIP COMPANY
We Go The Distance
Your Hunter Warranty

Hunter offers a limited warranty on every Hunter boat sold through an authorized Hunter dealer. A copy of this warranty is included here, and in your Operator's Manual. If for some reason you are not able to understand, read, or view this manual, please contact your local dealer for a replacement copy.

We stand behind the quality of your boat with a warranty, which you should review. To insure the validity of your warranty, please complete the attached card and send it to us within ten (10) days of the purchase date. Section 15 of the U.S. Federal Boat Safety Act requires registration of a boat's first owner. The warranty data should also be re-corded in the space below for your own reference.

The following warranties apply to all 2008 Model Year boats produced by
HUNTER MARINE CORPORATION:

===== LIMITED ONE-YEAR WARRANTY =====

Hunter Marine warrants to the first-use purchaser and any subsequent owner during the warranty period that any part manufactured by Hunter will be free of defects caused by faulty workmanship or materials for a period of twelve (12) months from the date of delivery to the first-use purchaser under normal use and service. During this period, as the sole and exclusive remedy, Hunter's obligation under the warranty is limited to the repair or replacement of any such defective part.

===== LIMITED FIVE-YEAR HULL STRUCTURE AND BOTTOM BLISTER WARRANTY =====

Hunter warrants to the first-use purchaser and any subsequent owner during the warranty period that the hull of each boat will be free from structural defects in materials and workmanship for a period of five (5) years from the date of delivery to the first-use purchaser under normal use and service.

This limited warranty applies only to the structural integrity of the hull and the supporting pan/grid or stringer system. Hulls, pan/grid or stringers modified in any way or powered with engines other than the type and size installed or specified by Hunter are not covered by this limited warranty. As the sole and exclusive remedy, Hunter's obligation under the warranty is limited to repair or replacement of any such defective part.

Hunter also warrants to the first-use purchaser and any subsequent owner during the warranty period that the boat will be free from gelcoat blistering on underwater surfaces of the hull, excluding the keel and rudder, for a period of five (5) years from the date of delivery to the first-use purchaser under normal use and service. During this period, Hunter will supply or reimburse an authorized Hunter dealer for all of the parts and labor required to repair a blistered underwater surface of the hull. The labor cost reimbursement will be based on the Labor Allowance Schedule established by Hunter from time to time, however if the repair is performed by a non-Hunter dealer, the repair cost must be authorized by Hunter in advance and be based on a reasonable number of hours as determined by Hunter. Hunter will not pay transportation, hauling, launching, bottom paint, storage, dockage, cradling rental, rigging and derigging, or other similar costs. It is recommended that the repair be done during a seasonal haul out for service or storage.

PLEASE KEEP THIS MANUAL IN A SAFE PLACE AND HAND IT OVER TO THE
NEW OWNER IF YOU SELL THE CRAFT.

You should also complete the warranty cards for your engine, and other accessories. These are enclosed in the manufacturers' manuals that are packaged with your owner's manual.

When purchased from Hunter or dealer with a new Boat.

HUNTER EXPRESSLY DISCLAIMS THE IMPLIED WARRANTIES OF
MERCHANTABILITY AND FITNESS. NEITHER HUNTER OR THE SELLING DEALER SHALL
HAVE ANY RESPONSIBILITY FOR LOSS OF USE OF A BOAT, LOSS OF TIME,
INCONVENIENCE, COMMERCIAL LOSS, OR CONSEQUENTIAL DAMAGES.

The following circumstances will void the bottom blister limited warranty:

- (1) If the gel-coat has been sanded, sandblasted, or subjected to abrasion or impact.
- (2) If the instructions provided in the Hunter Owner's Manual are not followed according to Hunter's required bottom preparation procedures.

////////////////////// RESTRICTIONS APPLICABLE TO WARRANTIES ////////////////////////

These limited warranties do not cover:

- (1.) Paint, window glass, Gelcoat, upholstery damage, plastic finishes, engines, engine parts, bilge pumps, stoves, blowers, pressure water pumps, propellers, shafts, rudders, controls, instruments, keels and equipment not manufactured by HUNTER. Any warranty made by the manufacturer of such items will be, if possible, given on to the first use purchaser.
- (2.) Problems caused by improper maintenance, storage, cradling, blocking, normal wear and tear, misuse, neglect, accident, corrosion, electrolysis or improper operation.
- (3) Boats used for commercial activities including charter.

THESE LIMITED WARRANTIES ARE YOUR SOLE AND EXCLUSIVE REMEDIES AND ARE EXPRESSLY IN LIEU OF ANY AND ALL OTHER REMEDIES AND WARRANTIES EXPRESSED AND IMPLIED, INCLUDING THE WARRANTIES OF MERCHANTABILITY AND FITNESS FOR A PARTICULAR PURPOSE, WHETHER ARISING BY LAW, CUSTOM, CONDUCT, OR USAGE OF TRADE. SOME STATES DO NOT ALLOW LIMITATIONS ON HOW LONG AN IMPLIED WARRANTY LASTS, SO THE ABOVE LIMITATION MAY NOT APPLY TO YOU. IN THE EVENT THAT IMPLIED WARRANTIES ARE FOUND TO EXIST UNDER THE LAW OF A PARTICULAR STATE, NOTWITHSTANDING THE EXCLUSION CONTAINED HEREIN, THE DURATION OF ANY SUCH IMPLIED WARRANTY SHALL BE LIMITED TO THE DURATION OF THE APPLICABLE LIMITED WARRANTY STATED HEREIN. THE PURCHASER ACKNOWLEDGES THAT NO OTHER REPRESENTATIONS WERE MADE TO HIM OR HER WITH RESPECT TO THE QUALITY OR FUNCTION OF THE BOAT. ANY ORAL STATEMENT OR PRINTED MATERIAL ADVERTISING THE BOAT WHICH SPEAKS TO ANY PERFORMANCE CHARACTERISTIC OF THE BOAT OR ANY OF ITS COMPONENTS SHALL BE CONSIDERED AND CON-STRUED AS AN ESTIMATED DESCRIPTION ONLY AND SHOULD NOT BE RELIED UPON AS AN EXPRESS WARRANTY OR AS THE BASIS OF THE BARGAIN FOR THE BOAT OR ANY OF ITS COMPONENTS.

ANY CONSEQUENTIAL, INDIRECT OR INCIDENTAL DAMAGES WHICH MAY BE INCURRED ARE EXCLUDED AND PURCHASER'S REMEDY IS LIMITED TO REPAIRS OR REPLACEMENT OF ANY PART(S) JUDGED DEFECTIVE BY HUNTER MARINE. SOME STATES DO NOT ALLOW THE EXCLUSION OR LIMITATION OF INCIDENTAL OR CONSEQUENTIAL OR INDIRECT DAMAGES, SO THE ABOVE LIMITATION OR EXCLUSION MAY NOT APPLY TO YOU. THIS WARRANTY GIVES YOU SPECIFIC LEGAL RIGHTS, AND YOU MAY ALSO HAVE OTHER RIGHTS WHICH VARY FROM STATE TO STATE.

OWNER INFORMATION CARD

HULL IDENTIFICATION NUMBER IS ON THE STARBOARD AFT SIDE OF THE HULL OR TRANSOM. THIS NUMBER MUST BE GIVEN IN ALL NECESSARY CORRESPONDENCE.

HULL NO. _____

DATE DELIVERED TO OWNER _____

YACHT NAME _____

OWNER NAME _____

STREET ADDRESS _____

CITY _____ STATE/COUNTRY _____ ZIP CODE _____

HOME PORT _____

ENGINE MODEL _____ SERIAL NO. _____ PROPELLER SIZE _____

DEALER _____ PHONE _____

STREET ADDRESS _____

CITY _____ STATE/COUNTRY _____ ZIP CODE _____

CUSTOMER SERVICE / WARRANTY

===== WARRANTY REGISTRATION =====

These limited warranties shall not be effective unless the HUNTER Warranty Registration Form and Pre-Delivery Service Record, which are furnished with each new boat, are filled out completely and re-turned to HUNTER within ten (10) days of delivery.

Return of the Warranty Registration Form to HUNTER, signed by both Dealer and Owner, is critical. Warranty coverage cannot be initiated until the completed form is received at HUNTER.

All repairs and/or replacements will be made by an authorized Hunter dealer, or at the option of Hunter, at the Hunter plant. If the repairs are of such a nature that the warranty work must be performed at the HUNTER plant, transportation costs to and from the HUNTER plant shall be paid by the owner. The labor cost reimbursement will be based on a Labor Allowance Schedule established by HUNTER and where not applicable, on a reasonable number of hours as determined by HUNTER. Any repairs and replacements must be approved in advance by an authorized HUNTER service representative.

===== TRANSFER OF LIMITED WARRANTIES =====

For 1995 and later hull numbers, the limited warranties will be transferred to a subsequent purchaser of the boat if:

- (1) A notice of the transfer of ownership of the boat is given by the subsequent purchaser in writing to Hunter within thirty (30) days of the transfer.
- (2) The notice shall include the name, address and telephone number of the subsequent purchaser, the date of purchase, the hull number and the name of the seller of the boat.

Hunter will mail to the subsequent purchaser notice of the expiration dates of the limited warranties (see form letter, attached). The transfer of the ownership of the boat will not extend the expiration dates of the limited warranties.

===== CUSTOMER SATISFACTION SURVEYS =====

During the first year of ownership, the first purchaser will receive two Customer Satisfaction Surveys - the first (CSS#1) will be received shortly after taking delivery and focuses on the dealer's ability to sell and commission the boat, and the Owner's initial satisfaction. The second survey (CSS#2), nine to ten months into ownership, "measures" dealer service capability and allows the owner to evaluate most of the boat's functional systems and characteristics. Both surveys are dependent upon receipt of the first purchaser's Warranty Registration Form.

SAMPLE FORM LETTER

March 12, 1997

Mr. John Smith
1456 Joy Street
Sarasota, FL 34266

Dear Mr. Smith,

Thank you for providing written notice of transfer of ownership. We are pleased you have selected a Hunter sailboat and we will make every effort to assure Hunter ownership will be a satisfying experience for you.

Based on the information you have provided, we are pleased to notify you of the expiration dates of the limited warranties.

- The limited one-year New Boat warranty expires (d) _____.
- The limited five-year Hull Structure and Bottom Blister warranty expires (d) _____.

Should you require assistance at any time during ownership, we encourage you to contact your Hunter dealer or to call us directly at 986-462-3077.

Please confirm the information at the bottom of the page and advise us if any corrections are required.

Customer Service Manager

Hull No: HUN _____ Model: _____

Telephone: (H) _____ (B) _____

Date of Purchase: _____

Purchased From: Name: _____

Address: _____

City/State _____ Zip _____

() Private Owner

() Dealer

HUNTER MARINE'S OWNER AND FOUNDER

WARREN R. LUHRS

BRIEF BACKGROUND

Warren Luhrs was born in East Orange, New Jersey in 1944 into a family with an established tradition in the maritime and transportation industries. His great-grandfather, Henry, was a railroad and clipper-shipping pioneer in America, while his great-uncle John helped build the famous St. Petersburg to Moscow railroad for Czar Alexander II.

Henry Luhrs owned shares in twenty-two different ocean-going vessels – barks, brigs, and schooners - and was the principal owner of the bark *Sophia R. Luhrs*, named for his wife. He was also a partner with Albert Sprout, who managed the shipyard where the *Sophia R. Luhrs* was built in Melbridge, Maine.

Warren Luhrs' father Henry worked at a small boat manufacturer in Morgan, New Jersey, and later started his own company, continuing the Luhrs' family sea tradition during the great depression. During World War II he repaired boats and installed ice sheathing on their bows for the Coast Guard.

After the War, Henry built 27-foot fishing boats and in 1948 began to construct custom-built pleasure craft. He then turned to skiffs and in 1952 incorporated as Henry Luhrs Sea Skiffs, where he constructed lapstrake sea skiffs using assembly-line techniques. Henry personally "shook down" his prototypes on family trips up the Hudson River to Lake Champlain.

The sea skiff is a class of boat that has been very popular, owing to its seaworthiness. It features a sharp bow,

which reduces pounding in surf or choppy seas, and a hull whose forward section is rounded below the waterline to increase stability in rough water or a following sea. Such skiffs can either be smooth sided or of a lapstrake construction.

Inspired by Henry Ford, Henry Luhrs' aimed to give the average man the opportunity to enjoy the luxury of boating by building an affordable and reliable boat. He was both designer and engineer, and his progressive new models exhibited his talent for innovation. He successfully changed the line of the bow from straight to curved at a time when the industry trend was a straight square effect, and he is believed to be the first designer-builder to popularize a small boat with a fly bridge.

In 1960, Luhrs acquired the Ulrichsen Boat Company of Marlboro, New Jersey. It was here that Luhrs' Alura fiberglass division was located. In 1965, Henry sold his company to Bangor Arrostock Railroad, which was to become the recreational conglomerate Bangor-Punta. It was also during this period that Silverton of Tom's River, New Jersey was purchased by John and Warren Luhrs.

Today, Warren R. Luhrs and his brother John own the Luhrs Group of marine manufacturers, which consists of Silverton Marine, Mainship Motor Yachts, and Luhrs Fishing Boats with its Alura division, as well as Hunter Marine, which exclusively manufactures sailboats.

In January of 1996, the Luhrs family transferred a portion of the Luhrs Group to its employees through an ESOP program.

GLOSSARY OF SAILING TERMS

A

Aback: describes a sail when the wind strikes it on the lee side.

Abaft: towards the boat's stern.

Abeam: at right angles to the *centerline* of the boat.

Aft: at or near the stern.

Amidships: the center of the boat, *athwartships* and fore and aft.

Anti-fouling: a poisonous paint compound used to protect the underwater part of a hull from marine growths.

Apparent wind: The direction and speed of the wind felt by the crew. It is a combination of *true wind* and that created by the movement of the boat.

Astern: behind the boat; to go astern is to drive the boat in reverse.

Athwartships: at right angles to the fore and aft line of the boat.

B

Back: when a wind backs, it shifts anticlockwise.

Back a sail: to sheet it to windward so that the wind fills on the side that is normally to *leeward*.

Backstay: a stay that supports the mast from aft and prevents its forward movement.

Ballast: extra weight, usually lead or iron, placed low in the boat or externally on the keel to provide stability.

Ballast keel: a mass of ballast bolted to the keel to increase stability and prevent a keel boat from capsizing.

Batten: a light, flexible strip fed into a batten pocket at the *leech* of the sail to support the *roach*.

Beam: 1, the maximum breadth of a boat; 2, a transverse member that supports the deck; 3, on the beam means that an object is at right angles to the centerline.

Bear away: to steer the boat away from the wind.

Bearing: the direction of an object from an observer, measured in degrees true or magnetic.

Beat: to sail a *zigzag course* towards the wind, *close-hauled* on alternate *tacks*.

Belay: to make fast a rope around a *cleat*, usually with a figure-of-eight knot.

Bend: 1, to secure a sail to a spar before hoisting; 2, to moor a boat; 3, a sleeping place on board.

Bight: a *bend* or loop in a rope.

Bilge: the lower, round part inside the hull where the water collects.

Block: a pulley in a wooden or plastic case, consisting of a *sheave* around which a rope runs. It is used to change the direction of pull.

Boot-topping: a narrow colored stripe painted between the bottom paint and the *topside* enamel.

Bottlescrew: see Rigging screw.

Broach: when a boat *running* downwind slews broadside to the wind and *heels* dangerously. It is caused by heavy following seas or helmsman's error.

Broad reach: the point of sailing between a beam *reach* and a *run*, when the wind blows over a quarter.

Bulkhead: a partition wall in a boat normally fitted *athwartships*

C

Caulk: to make the seams between wooden planks watertight by filling with cotton, oakum or a compound.

Cavitation: the formation of a vacuum around a propeller, causing a loss in efficiency.

Center-board: a board lowered through a slot in the *keel* to reduce *leeway*.

Center-line: center of the boat in a fore and aft line.

Center of effort (COE): the point at which all the forces acting on the sails are concentrated.

Center of lateral resistance (CLR): the underwater center of pressure about which a boat pivots when changing *course*.

Chain pawl: a short lug which drops into a toothed rack to prevent the anchor chain running back.

Chain plate: a metal plate bolted to the boat to which the *shrouds* or *backstays* are attached.

Chart datum: reference level on a chart below which the tide is unlikely to fall. Soundings are given below chart datum. The datum level varies according to country and area.

Chine: the line where the bottom of the hull meets the side at an angle.

Cleat: a wooden, metal or plastic fitting around which rope is secured.

Clevis pin: a locking pin through which a split ring is passed to prevent accidental withdraw.

Clew: the after, lower center of a sail where the foot and *leech* meet.

Close-hauled: the *point of sailing* closest to the wind; see also *beat*.

Close reach: the *point of sailing* between *close-hauled* and a beam reach, when the wind blows forward of the *beam*.

Close-winded: describes a boat able to sail very close to the wind.

Coaming: the raised structure surrounding a hatch, cockpit, etc., which prevents water entering.

Cotter pin: soft, metal pin folded back on itself to form an eye.

Course: the direction in which a vessel is steered, usually given in degrees; true, magnetic or compass.

Cringle: 1, a rope loop, found at either end of a line of reef points; 2, an eye in a sail.

D

Dead run: running with the wind blowing exactly aft, in line with the *centerline*.

Deviation: the difference between the direction indicated by the compass needle and the magnetic *meridian*; caused by object aboard.

Displacement: 1, the weight of water displaced by a boat is equal to the weight of the boat; 2, a displacement hull is one that displaces its own weight in water and is only supported by buoyancy, as opposed to a planing hull which can exceed its hull, or displacement, speed.

Downhaul: a rope fitted to pull down a sail or spar.

Draft: the vertical distance from the waterline to the lowest point of the keel.

Drag: 1, an anchor drags when it fails to hole; 2, the force of wind on the sails, or water on the hull, which impedes the boat's progress.

Drift: 1, to float with the current or wind; 2, US the speed of a current

GLOSSARY OF SAILING TERMS

(rate UK); 3, UK: the distance a boat is carried by a current in a given time.

Drogue: a sea anchor put over the stern of a boat or life raft to retard *drift*.

Drop keel: a retractable *keel* which can be drawn into the hull, when entering shallow waters and recovering on to a trailer.

E

Eye of the wind: direction from which the true wind blows.

F

Fair: well-faired line or surface is smoother with no bumps, hollows or abrupt changes in directions.

Fairlead: a fitting through which a line is run to alter the lead of the line.

Fathom: the measurement used for depths of water and lengths of rope. 1 fathom = 6 ft. or 1.83m.

Fid: a tapered tool used for *splicing* heavy rope and for sail-making, often hollow.

Fiddle: a raised border for a cabin table, chart table etc., to prevent objects falling off when the boat *heels*.

Fix: the position of the vessel as plotted from two or more position lines.

Forestay: the foremost stay, running from the masthead to the stemhead, to which the headsail is hanked.

Freeboard: vertical distance between the *waterline* and the top of the deck.

G

Genoa: a large headsail, in various sizes, which overlaps the mainsail and is hoisted in light to fresh winds on all points of *sailing*.

Gimbals: two concentric rings, pivoted at right angles, which keeps objects horizontal despite the boat's motion, e. g. compass and cooker.

Go about: to turn the boat through the *eye of the wind* to change tack.

Gooseneck: the fitting attaching the boom to the mast, allowing it to move in all directions.

Goosewing: to boom-out the headsail to windward on a run by using a *whisker pole* to hold the sail on the opposite side to the mainsail.

Ground tackle: general term used for anchoring gear.

Guard rail: a metal rail fitted around the boat to prevent the crew falling overboard.

Gudgeon: a rudder fitting. It is the eye into which the *pintle* fits.

Guy: a steadying rope for a spar; a spinnaker guy controls the fore and aft position of the spinnaker pole; the foreguy holds the spinnaker pole forward and down.

Gybe: to change from one *tack* to another by turning the stern through the wind.

H

Halyard: rope used to hoist and lower sails.

Hank: fitting used to attach the *luff* of a sail to a stay.

Hatch: an opening in the deck giving access to the interior.

Hawes pipe: see *Navel pipe*.

Head-topwind: when the bows are pointing right into the wind.

Headfoil: a streamlined surround to a *forestay*, with a groove into which a headsail *luff* slides.

Heads: the toilet.

Headway: the forward movement of a boat through the water.

Heave-to: to *back* the jib and lash the tiller to *leeward*; used in heavy weather to encourage the boat to lie quietly and to reduce *headway*.

Heaving line: a light line suitable for throwing ashore.

Heel: to lean over to one side.

I

Isobars: lines on a weather map joining places of equal atmospheric pressure.

J

Jackstay: a line running fore and aft, on both sides of the boat, to which safety harnesses are clipped.

Jury: a temporary device to replace lost or damaged gear.

K

Keel: the main backbone of the boat to which a *ballast keel* is bolted or through which the *centerboard* passes.

Kicking strap: a line used to pull the boom down, to keep it horizontal, particularly on a reach or run.

L

Lanyard: a short line attached to one object, such as a knife, with which it is secured to another.

Leech: 1, the after edge of a triangle sail; 2, both side edges of a square sail.

Leehelm: the tendency of a boat to bear away from the wind.

Lee shore: a shore on to which the wind blows.

Leeward: away from the wind; the direction to which the wind blows.

Leeway: the sideways movement of a boat off its *course* as a result of the wind blowing on one side of the sails.

Lifeline: a wire or rope rigged around the deck to prevent the crew falling overboard.

Limber holes: gaps left at the lower end of frames above the *keel* to allow water to drain to the lowest point of the *bilges*.

List: a boat's more or less permanent lean to one side, owing to the improper distribution of weight, e.g., *ballast* or water.

Log: 1, an instrument for measuring a boat's speed and distance traveled through the water; 2, to record in a book the details of a voyage, usually distances covered and weather.

Luff: the forward edge of a sail. To luff up is to turn a boat's head right into the wind.

Luff groove: a groove in a wooden or metal spar into which the *luff* of a headsail is fed.

Lurch: the sudden roll of a boat.

M

Marlin spike: a pointed steel or wooden spike used to open up the strands of rope or wire then splicing.

Mast Step: the socket in which the base of the mast is located.

Measured mile: a distance of one nautical mile measured between buoys or *transits/ranges* ashore, and marked on the chart.

GLOSSARY OF SAILING TERMS

Member: a part of the skeleton of the hull, such as a *stringer* laminated into fiberglass hull to strengthen it.

Meridian: an imaginary line encircling the Earth that passes through the poles and cuts at right angles through the Equator. All lines of longitude are meridians.

Mizzen: 1, the shorter, after-mast on a *ketch* or *yawl*; 2, the fore and aft sail set on this mast.

N

Navel pipe: a metal pipe in the fore-deck through which the anchor chain passes to the locker below.

Noon Sight: a vessel's latitude can be found, using a sextant, when a heavenly body on the observer's *meridian* is at its greatest altitude. The sight of the sun at noon is the one most frequently taken.

O

Off the wind: with the sheets slacked off, not *close-hauled*.

On the wind: *close-hauled*.

Out haul: a rope used to pull out the foot of a sail.

Overall length (OAL): the boat's extreme length, measured from the foremost part of the bow to the aftermost part of the stern, excluding bowsprit, self-steering gear etc.

P

Painter: the bow line by which a dinghy, or *tender*, is towed or made fast.

Pintle: a rudder fitting with a long pin that fits into the *gudgeon* to form a hinged pivot for the rudder.

Pitch: 1, the up and down motion of the bows of a boat plunging over the waves; 2, the angle of the propeller blades.

Point of sailing: the different angles from which a boat may sail; the boat's *course* relative to the direction of the wind.

Port: the left-hand side of the boat, looking forward (opp. of *starboard*).

Port tack: a boat is on a port tack when the wind strikes the port side first and the mainsail is out to *starboard*. A boat on the port tack gives way to a boat on a starboard tack.

Position line/ Line of position: a line drawn on a chart, as a result of taking a bearing, along which the boat's position must be, i.e. two position lines give a fix.

Pulpit: a metal *guard rail* fitted at the bows of a boat to provide safety for the crew.

Pushpit: a metal *guard rail* fitted at the stern.

Q

Quarter: the portion of the boat midway between the stern and the beam; on the quarter means about 45 degrees *abaft* the beam.

R

Rake: the fore and aft deviation from the perpendicular of a mast or other feature of a boat.

Range: 1, see *transit*; 2, of tides, the difference between the high and low water levels of a tide; 3, the distance at which a light can be seen.

Rating: a method of measuring certain dimensions of a yacht to enable it to take part in handicap races.

Reach: to sail with the wind approximately on the *beam*; all sailing points between running and *close-hauled*.

Reef: to reduce the sail area by folding or rolling surplus material on the boom or *forestay*.

Reefing pennant: strong line with which the *luff* or leech *cringle* is pulled down to the *boom* when reefing.

Rhumb line: a line cutting all *meridians* at the same angle; the *course* followed by a boat sailing in a fixed direction.

Riding light to anchor light: an all-around white light, usually hoisted on the *forestay*, to show that a boat under 50 ft. (15m.) is at anchor. It must be visible for 2 mls. (3 km.).

Rigging screw: a deck fitting with which the tensions of standing rigging, e.g. stays, shrouds, etc. are adjusted.

Roach: the curved part of the *leech* of a sail that extends beyond the direct line from head to *clew*.

Run: to run with the wind *aft* and with the *sheets* eased well out.

Running rigging: all the moving lines, such as *sheets* and *halyards*,

used in the *setting* and *trimming* of sails.

S

Scope: the length of rope or cable paid out when mooring or anchoring.

Scuppers: 1, holes in the toe rail that allow water to drain off the deck; 2, drain cockpit through hull.

Seacock: a valve that shuts off an underwater inlet or outlet passing through the hull.

Seize: to bind two ropes together, or a rope to a *spar*, with a light line.

Serve: to cover and protect a *splice* or part of a rope with twine bound tightly against the lay.

Serving mallet: tool with a grooved head, used when serving a rope to keep the twine at a constant and high tension.

Set: 1, to hoist a sail; 2, the way in which the sails fit; 3, the direction of tidal current or steam.

Shackle: a metal link with a removable bolt across the end; of various shapes: D, U.

Sheave: a grooved wheel in a *block* or *spar* for a rope to run on.

Sheet: the rope attached to the *clew* of a sail or to the boom, enabling it to be controlled or *trimmed*.

Shrouds: ropes or wires, usually in pairs, led from the mast to the *chain plates* at deck level to prevent the mast falling sideways; part of the standing rigging.

Sloop: a single-masted sailing boat with a mainsail and one head sail.

Spar: a general term for any wooden or metal pole, e.g., mast or boom, used to carry or give shape to sails.

Spindrift: spray blown along the surface of the sea.

Spinnaker: a large, light, balloon shaped sail set when *reaching* or *running*.

Splice: to join ropes or wire by unlaying the strands and interweaving them.

Split pin: see *cotter pin*.

Spreaders: horizontal struts attached to the mast, which extends to the *shrouds* and help to support the mast.

GLOSSARY OF SAILING TERMS

Stall: a sail stalls when the airflow over it breaks up, causing the boat to lose way.

Stanchion: upright metal post bolted to the deck to support guardrails or lifelines.

Standing part: the part of a line not used when making a knot; the part of a rope that is made fast, or around which the knot is tied.

Standing rigging: the shrouds and stays that are permanently set up and support the mast.

Starboard: right-hand side of a boat looking forward (opp. of *port*).

Starboard tack: a boat is the starboard tack when the wind strikes the starboard side first and the boom is out to the *port*.

Stay: wire or rope which supports the mast in a fore and aft direction; part of the *standing rigging*.

Steerage way: a boat has steerage way when it has sufficient speed to allow it to be steered, or to answer the helm.

Stem: the timber at the bow, from the keel upward, to which the planking is attached.

Sternway: the backward, stern-first movement of a boat.

Stringer: a fore and aft member, fitted to strengthen the frames.

T

Tack: 1, the lower forward corner of a sail; 2, to turn the boat through the wind so that it blows on the opposite sides of the sails.

Tacking: working to windward by sailing *close-hauled* on alternate *courses* so that the wind is first on one side of the boat, then on the other.

Tack pennant: a length of wire with an eye in each end, used to raise the tack of a headsail some distance off the deck.

Tackle: a purchase system comprising of rope and *blocks* that is used to gain mechanical advantage.

Tang: a strong metal fitting by which *standing rigging* is attached to the mast or other *spar*.

Tender of dinghy: a small boat used to ferry stores and people to a yacht.

Terminal fitting: fitting at the end of a wire rope by which a *shroud* or stay can be attached to the mast, a *tang* or a *rigging screw/turnbuckle*.

Tide: the vertical rise and fall of the oceans caused by the gravitational attraction of the moon.

Toe rail: a low strip of metal or molding running around the edge of the deck.

Topping lift: a line from the masthead to a spar, normally the boom, which is used to raise it.

Topsides: the part of a boat's hull that is above the waterline.

Track: 1, the course a boat has made good; 2, a fitting on the mast or boom into which the slides on a sail fit; 3, a fitting along which a traveller runs, used to alter the angle of the sheets.

Transit: two fixed objects are in transit when seen in line; two transit give position fix.

Traveller: 1, a ring or hoop that can be hauled along a *spar*; 2, a fitting that slides in a *track* and is used to alter the angle of the *sheets*.

Trim: 1, to adjust the angle of the sails, by means of *sheets*, so that they work most efficiently; 2, to adjust the boat's load, and thus the fore and aft angle at which it floats.

True wind: the direction and speed of the wind felt when stationary, at anchor or on land.

Turnbuckle: see *Rigging screw*.

U

Under way: a boat is under way when it is not made fast to shore, at anchor or aground.

Uphaul: a line used to raise something vertically, e.g., the spinnaker pole.

V

Veer: 1, the wind veers when it shifts in clockwise direction; 2, to pay out anchor cable or rope in a gradual, controlled way.

W

Wake: the disturbed water left *astern* of a boat.

Waterline: the line along the hull at which a boat floats.

Waterline length (WL): the length of a boat from *stem* to *stern* at the *waterline*. It governs the maximum speed of *displacement hull* and effects a boat's *rating*.

Weather helm: (opp. of *lee helm*).

Weather side: the side of a boat on which the wind is blowing.

Wetted surface: the area of the hull under water.

Whisker pole: a light pole used to hold out the *clew* of a headsail when *running*.

Winch: a mechanical device, consisting usually of a metal drum turned by a handle, around which a line is wound to give the crew more purchasing power when hauling taut a line, e.g. a *jib sheet*.

Windage: those parts of a boat that increase *drag*, e.g., rigging, spars, crew, etc.

Windlass: a *winch* with a horizontal shaft and a vertical handle, used to haul up the anchor chain.

Windward: the direction from which the wind blows; towards the wind (opp. of *leeward*).

Y

Yawl: a two masted boat with a mizzen stepped aft of the rudder stock/post.

FLOAT PLAN

1. Name of person reporting and telephone number:

2. Description of boat

NAME	TYPE	
MAKE	LENGTH	REGISTRATION#
HULL COLOR	STRIPE COLOR	DECK COLOR
OTHER DISTINGUISHING MARKS		

3. Number of Persons aboard

NAME	AGE	PHONE #
ADDRESS		
NAME	AGE	PHONE #
ADDRESS		
NAME	AGE	PHONE #
ADDRESS		

4. Engine

TYPE	H.P.	FUEL CAPACITY
------	------	---------------

5. Safety equipment

PFDs	<input type="checkbox"/>	Flares	<input type="checkbox"/>	Mirror	<input type="checkbox"/>	Flashlight	<input type="checkbox"/>
Food	<input type="checkbox"/>	Water	<input type="checkbox"/>	EPIRB	<input type="checkbox"/>	Raft/Dinghy	<input type="checkbox"/>

6. Radio

TYPE	FREQUENCIES
------	-------------

7. Trip Expectations

DEPARTURE TIME	DATE	FROM
DESTINATION	RETURN DATE	NO LATER THAN

8. Automobile:

LICENSE #	STATE	MAKE
COLOR	PARKED AT	

9. If not returned by-

Contact the Coast Guard or-

CALL - _____ AT- _____

EXPLANATION OF SAFETY PRECAUTIONS

This manual contains safety precautions that must be observed when operating or servicing your boat.

Review and understand these instructions.

DANGER

Denotes an extreme intrinsic hazard exists which would result in high probability of death or irreparable injury if proper precautions are not taken

WARNING

Denotes a hazard exists which can result in injury or death if proper precautions are not taken

CAUTION

Denotes a reminder of safety practices or directs attention to unsafe practices which could result in personal injury or damage to the craft or components

SAFE BOATING TIPS

BE PREPARED

Take a safe boating course. In the U.S., contact your local Boating Industry for details.

Carry all safety equipment required by the laws that apply to your area. Requirements are generally available from the Coast Guard or your local boating industry.



WARNING

As the owner of the craft, obtaining and maintaining necessary safety equipment is your responsibility. For more information about equipment required, contact local boating authorities

MINIMUM RECOMMENDED SAFETY EQUIPMENT

- Required life saving equipment, including life vests and throwables.
- First Aid kit
- Anchor with sufficient line and/or chain
- Flashlight with good batteries
- Binoculars
- Appropriate navigational charts
- Flares
- Noise emitting device
- Sufficient food and water provisions
- Sunglasses and block
- Blanket
- Oar(s)

The legally required on-board safety equipment may vary by region or body of water. Please check with local authorities prior to departure for a safety examination.

LIFE JACKETS

A life jacket may save your life, but only if you wear it. Keep jackets in a readily accessible place – not in a closed compartment or stored under other gear. Remove them from any packaging, and keep throwable floatation devices ready for immediate use.



WARNING

It is very important that children, handicapped people, and non-swimmers wear lifejackets at all times. Make sure all passengers are properly instructed in use of life saving gear

FIRE EXTINGUISHERS

Approved fire extinguishers are required on most boats, local authorities can provide details. All passengers should know the location and operating procedure of each fire extin-

guisher. Fire extinguishers are normally classified according to fire type. Be familiar with the type of fire extinguishers you have on board.

SAFE BOATING TIPS

FLARES

Most boats operating on coastal waters are required to carry approved visual distress signals, therefore check with your local authorities as to which types are required.

 WARNING
FIRE/EXPLOSION HAZARD; Pyrotechnic signaling devices can cause injury and property damage if not handled properly. Follow manufacturer's directions regarding the proper use of signaling devices.

DRUGS AND BOATING

Consumption of alcohol while boating is not recommended. The combination of noise, sun, wind, and motion act to produce fatigue on the water, and can exaggerate the effects of alcohol.

 WARNING
IMPAIRED OPERATION HAZARD Operating any boat while is intoxicated or under the influence of drugs is both dangerous and illegal. Impaired vision or judgment on the water can lead to accidents and personal injury

BEFORE GETTING UNDERWAY

- Leave a float plan (example included).
- Perform a pre-departure checklist (example included).
- Check the weather. Do not venture out if the weather is, or will be, threatening.

WHILE UNDERWAY

- Keep a good lookout. Keep a watch to the leeward under the headsail. Keep away from swimmers, divers, and skiers.
- Know and obey local boating laws.
- Respect bad weather, and be prepared for quickly changing conditions.

 WARNING
COLLISION HAZARD Use extra caution in shallow water or where underwater/floating objects may be present. Hitting an object at speed or severe angle can seriously injure people and damage your boat

LAUNCHING & RETRIEVING PROCEDURES

LAUNCHING

1. Remove any and all tie down straps and ropes securing the boat to the trailer, as well as any lines securing the rudder in the upright position or on centerline. The only attachment of the boat to the trailer should be the strap from the bow eye to the trailer winch.
2. The spar can be raised before or after launch, depending on the time available before and the docking facilities available after launch. **Beware of nearby power lines before raising spar.**
3. Attach the necessary bow and stern mooring lines and fenders if necessary. Do not lower the fenders over the side until the boat is clear of the trailer.
4. Initially slacken the trailer winch and familiarize yourself with its gear switch action and return the winch to the locked position.

5. Load all loose gear and provisions aboard by lowering the swim ladder in the transom.
6. Back the boat and trailer down the ramp until the back wheels of the vehicle are just clear of the water, Retrieve the bow and stern lines as necessary. Loosen the trailer winch and bow strap.
7. Once the boat is floating free, push the boat clear of the trailer guides to the available dock, maintaining control with the mooring lines.
8. Slowly pull the empty trailer out of the water, being careful that boat and people stay clear.
9. Park the trailer and vehicle and return to the boat.

RETRIEVING

1. Raise centerboard and rudder.
2. Back trailer into water.
3. Maneuver boat between trailer guides and up to the winch.
4. Connect bow strap and with winch in correct gear, winch boat up and snug against bow stop.
5. Center boat between upright aft trailer guides.

6. Slowly pull boat from water until the weight of the boat is on the trailer.
7. Confirm alignment on trailer. Put trailer back in water if necessary to realign boat.
8. Make sure that rudder is pinned or tied in upright position so that the tip doesn't drag on ground.
9. De-rig and unstep mast if not already done. **Beware of nearby power lines when lowering mast.**
10. Tie boat to trailer, and secure mast.

GENERAL CARE

NOTICE

Your new Hunter is built using the ACP process. This is not a Fiberglass® boat!

The outer skin is a weatherable ABS plastic known as Luran® S and is built by BASF. The outer plastic skin is approximately .170" thick.

CLEANING LURAN® S SURFACES

Luran® S (acrylonitrile/styrene/acrylate) should be cleaned regularly. Normal accumulations of dirt can be removed simply by occasional rinsings with water. If your boat is operated in salt water, more frequent rinsing will be required. To remove dirt, grease or oil, use soap and water or isopropyl alcohol. For stubborn stains, you can use mineral spirits but never leave a rag with mineral spirits on it lying on your boat.

For more extensive repairs, contact the factory.

When storing, please open the drain plugs so the boat can breathe. When trailering make sure the boat is well supported so as not to dent the hull.

You can wax the surface if you would like, but be aware this will make the boat slippery. For light scratches you can use a wax with a light rubbing compound or a mirror glaze which is available at any hardware store.

! CAUTION

Never leave a rag with mineral spirits sitting on the boat as this will attack the plastic and void the warranty. Never use acetone or other solvents. They will damage the finish on your boat.

CLEANING ACRYLIC

Use only mild soap and water to clean acrylics. Do not use products containing solvents such as ammonia, which is found in many window cleaners.

! CAUTION

Use care when cleaning acrylic. Dry cloth and many glass cleaners will scratch. Solvents will attack the surface.

! WARNING

Cleaning agents and paint ingredients may be flammable and/or explosive, or dangerous to inhale. Be sure to use adequate ventilation, and appropriate safety clothing (gloves, safety glasses, respirator, etc.). _____

GENERAL CARE

SHALLOW SURFACE SCRATCHES

Remove the scratches by lightly hand wet sanding the surface with 600 grit sandpaper. Sand only until the scratches are removed (to retain as much thickness as possible). This will create a dull surface. To improve the surface

gloss, sand the area with 1000 grit, then 1500 grit sandpaper. The surface should be starting to recover some of the gloss. To further increase the gloss level, polish the area with ultra fine polish (automotive polishes suitable for clearcoat).

COSMETIC DAMAGE

Cosmetic damage is defined as a problem that does not affect the overall structure of the part or area. They are usually appearance concerns, such as scratches, surface mars, and minor dents. It is very important to ascertain the full extent of the damaged area. If any jagged edges or cracks are present, see the consequential damage section.

Mask off the damaged area, lightly hand sand (220 grit) the damaged area to remove any surface ridges and to promote adhesion. Sand in

one direction only. In a well-ventilated area, apply a thin layer of Plexus adhesive in a 1:1 ratio to the damaged area. After the Plexus has dried, smooth the area with a fine (220 grit) sandpaper. Now, apply a thin layer of MA310 Plexus or Marine Tex to fill in any imperfections, and allow to dry. Lightly sand with a 220 grit sandpaper, followed by a 400 grit sandpaper, then a 600 grit sandpaper. Finally, apply an Krylon Fusion to match the color.

CONSEQUENTIAL DAMAGE

This type of damage can be holes, cracks, or large dents. Cracks, even those found around holes, must be prevented from growing. To do this, the ends must be found and blunted (by drilling small holes). Once this is done, the crack can be ground or routed into a V groove. This allows it to be filled easily and promotes a good bond. We suggest using a Dremel tool, being sure to work in a well-ventilated area.

Mask off the damaged area and lay down a bead of Plexus adhesive in a 1:1 ratio into the damaged area, slightly under filling the V groove.

The Plexus will expand as it hardens. Skim the excess Plexus (if any) from the repair area keeping it level with the surrounding area. Allow to dry for 1 hour. Sand the damaged area until the surface is flush with the surrounding area. Apply a thin layer of MA310 Plexus or Marine Tex to fill any voids. Allow the filler to dry, then wet sand with 220, 400, then 600 grit sandpaper.

After sanding the repaired area flush to the surrounding area, paint can then be applied. Recommended paints are 1501 Krylon Fusion 2320 gloss white.

SAFETY CONSIDERATIONS:

Use of solvents requires adequate ventilation, keeping in mind that they are usually highly flammable. Use proper procedures to avoid injury. In some instances, the use of these materials is controlled. Check all regulations prior to using.

Keep in mind that a repair can only attempt to match the performance predicted in the original part. The repair may not be quite as strong or stiff as the original part. The overall part/system behavior has probably changed.

Always follow all warnings and instructions given by the manufacturers of the products used for repairs.

This information is provided for your guidance only. We urge you to make all tests you deem appropriate prior to use. No warranties, either expressed or implied, including warranties or merchantability or fitness for a particular purpose, are made regarding products described or information set forth, or that such products or information may be used without infringing patents of others.

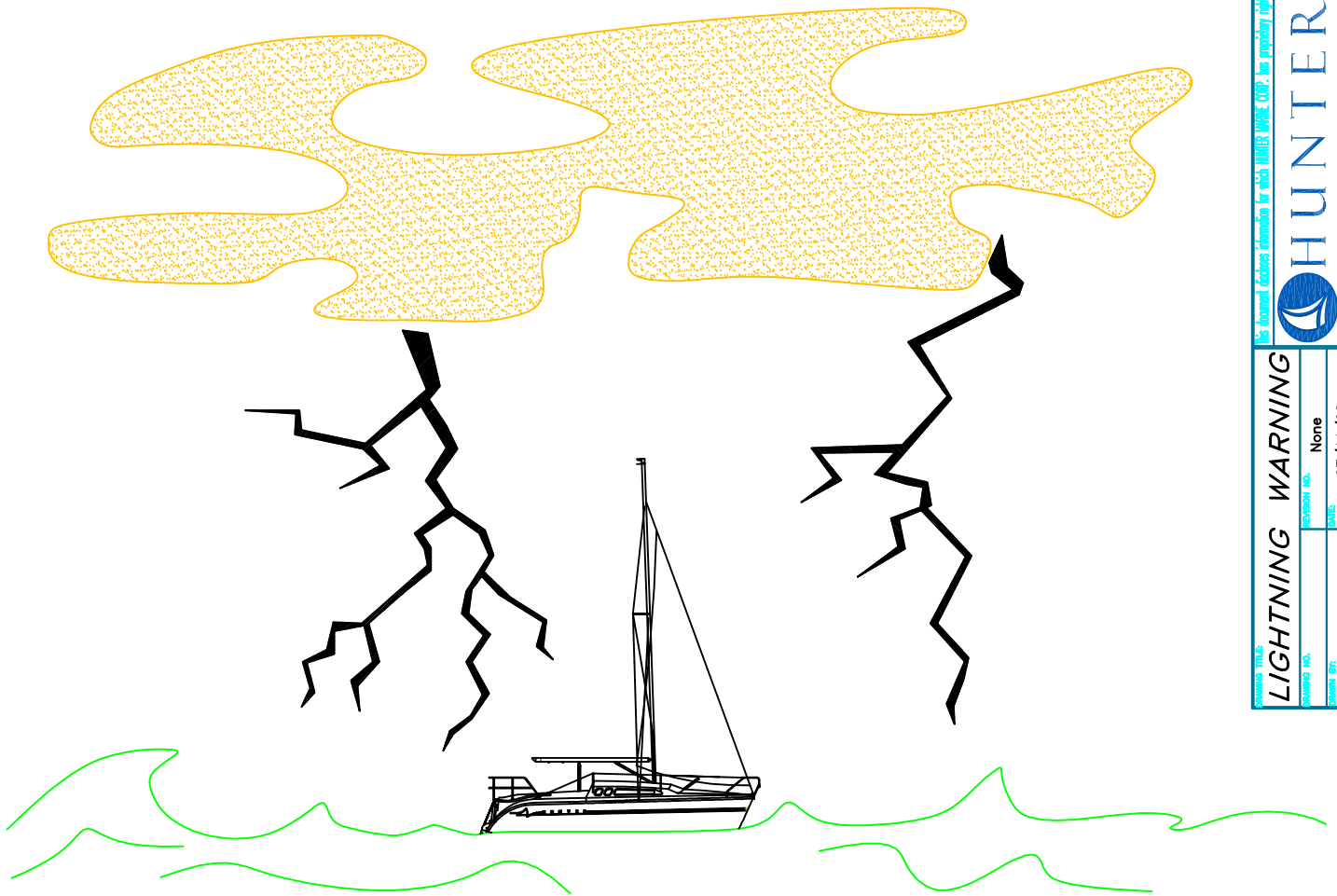

LIGHTNING STORM WARNING:

1. ALL WHIP ANTENNAS SHOULD BE TIED DURING STORM, UNLESS PART OF THE LIGHTNING PROTECTION SYSTEM.
2. PRECAUTIONS: DURING LIGHTNING STORMS: A. THE SHIP'S OCCUPANTS SHOULD TAKE SHELTER INSIDE A CLOSED AREA OF THE BOAT. EXAMPLE: BELOW DECK. B. OCCUPANTS SHOULD NOT HAVE ANY BODY PARTS IN THE WATER. C. AVOID CONTACT WITH ANY COMPONENTS OF THE L.P.S. AND D. AVOID ALL CONTACT WITH ANY METAL OBJECTS.
3. SEE DIAGRAM BELOW FOR INFORMATION ON THE LIGHTNING PROTECTION ZONE.
4. IF LIGHTNING SHOULD STRIKE THE SHIP, INSPECT ALL ELECTRONICS, ELECTRIC GEAR, COMPASS AND L.P.S. SYSTEM FOR POSSIBLE DAMAGE. RECALIBRATE AS NECESSARY. NOTE: BEGIN CHECKING ELECTRONICS AFTER THE THREAT OF LIGHTNING HAS PASSED.

FAILURE TO FOLLOW PRECAUTIONS MAY RESULT IN SEVERE INJURY OR DEATH

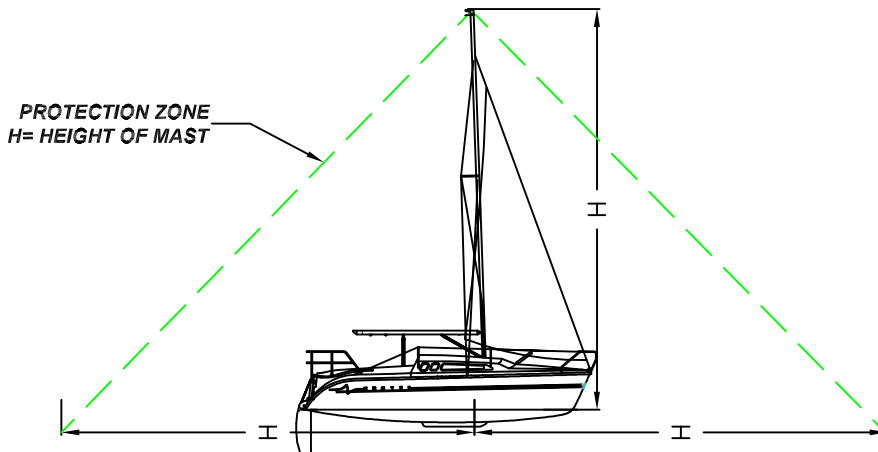

A.C.P.

ADVANCED COMPOSITE PROCESS

- **ACP: The most innovative Boatbuilding process today**

ACP is a plastic based process which uses an outer plastic skin, a central foam core and an inner fiberglass skin. The outer plastic skin is 1/4" thick and is an extrusion of high impact resistant ABS and UV resistant plexiglas. The plastic components are formed by using a process known as thermoforming which uses a vacuum to draw heated plastic onto a mold.

Repairs can be made quickly, cleanly and easily using our two part patch kit. Should you have any questions, a Hunter service consultant can walk you through almost any repair over the phone.

- **Send in the reinforcements**

This plastic skin is then reinforced with a foam core by placing the plastic hull in a matched mold with a 1" gap between the plastic and the mold. Liquid foam is then injected into the void under high pressure. The foam expands, conforming to the shape of the hull, and becomes the middle layer of the composite.

The third strain consists of fiberglass cloth. The cloth is attached to the mold during the foaming process and is integrated into the hull as the foam expands.

- **Benefits**

- ◇ **Strength:** ACP is five times stronger than fiberglass and because there are no fibers to breakdown, the hull will not become "soft".
- ◇ **Cost:** the ACP process is less labor intensive resulting in a lower priced boat.
- ◇ **Environmentally Friendly:** The ACP process is much more environmentally friendly than fiberglass production. The amended Clean Air Act, which took effect in 1996, greatly restricted all fiberglass manufacturing by putting a severe limit on styrene emissions.

DIMENSIONS, CAPACITIES, ETC.

DESCRIPTION:

JY 15

Lenght overall (LOA) -----	15' 0" (4.57m)
Beam (MAX) -----	5' 10" (1.78m)
Draft: Centerboard up -----	6" (0.15m)
Centerboard down -----	3' (0.92m)
Sail Area -----	135 sq.ft (12.56 sq.m)
Mast height -----	22'0" (6.70m)
Towing Weight -----	550 lb (227 kg)
Weight - Loaded -----	935 lb (424 kg)
Maximum loading (Persons/Luggage) -----	5 Persons

▼ CAUTION ▼

Use a light colored material (white, tan, light grey) to cover your boat in order to minimize heat buildup and potential sun damage. Do not use a dark cover or dark shrinkwrap for storage.

This document contains information for which HUNTER MARINE CORP. has proprietary rights.

HUNTER

FORM TITLE JY15 DIMENSIONS AND CAPACITIES	REVISION NO. None	DATE 10/19/07
DESIGN NO. JY158009	SCALE ENG	

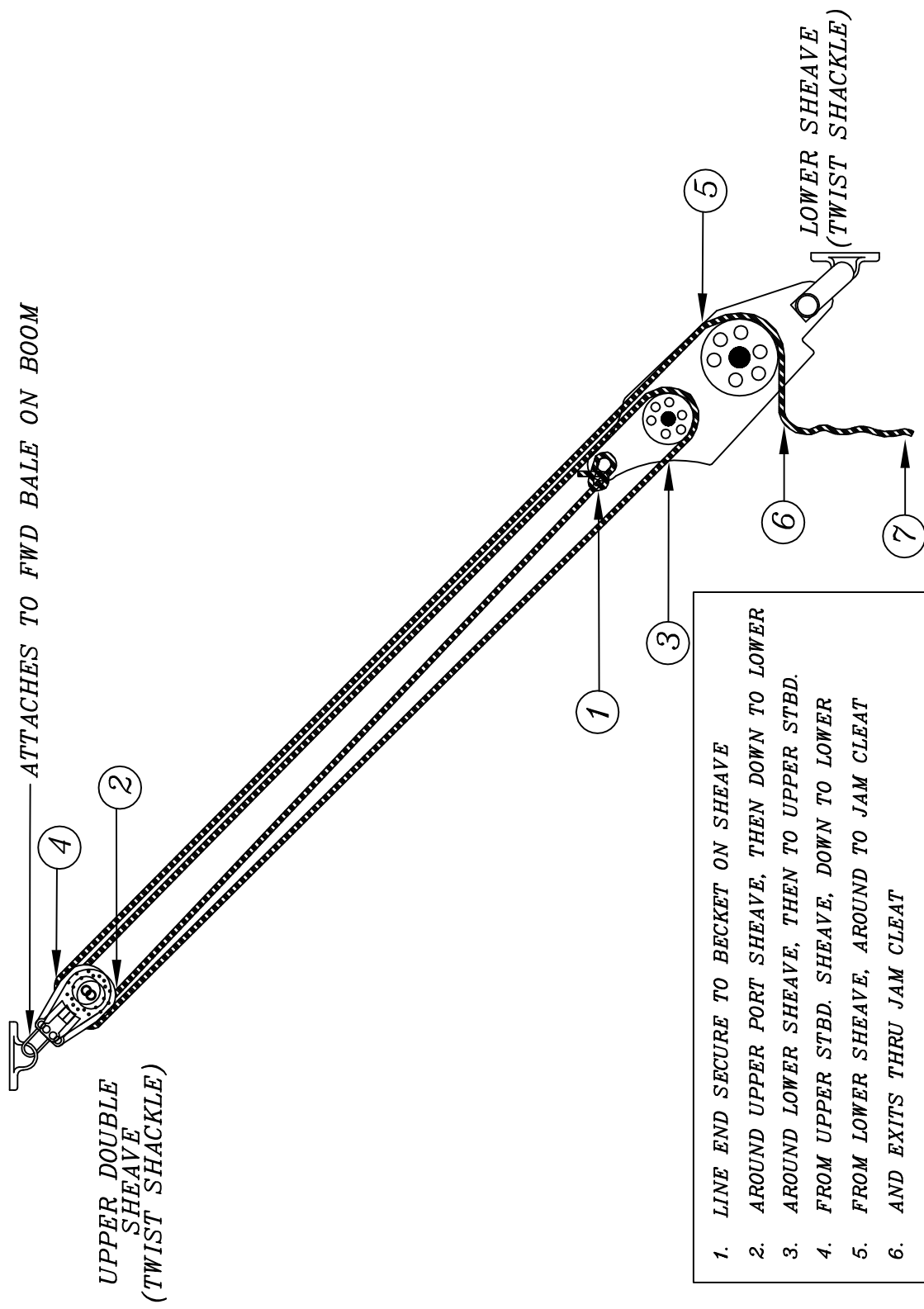

ATTACHES TO FWD BALE ON BOOM

UPPER DOUBLE SHEAVE (TWIST SHACKLE)

LOWER SHEAVE (TWIST SHACKLE)

1. LINE END SECURE TO BECKET ON SHEAVE
2. AROUND UPPER PORT SHEAVE, THEN DOWN TO LOWER
3. AROUND LOWER SHEAVE, THEN TO UPPER STBD.
4. FROM UPPER STBD. SHEAVE, DOWN TO LOWER
5. FROM LOWER SHEAVE, AROUND TO JAM CLEAT
6. AND EXITS THRU JAM CLEAT
7. TIE A FIGURE EIGHT KNOT IN END OF LINE TO PREVENT UN-REEVING

UPPER FORESTAY/SIROUD/TOPPING LIFT ATTACHMENT

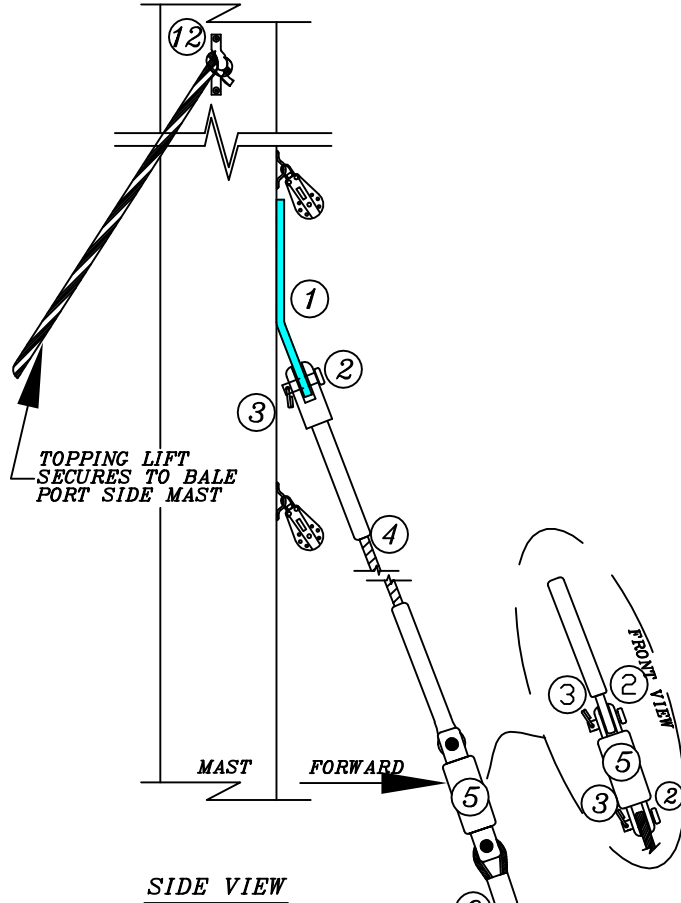

- ① FORESTAY/SIROUD TANG
- ② CLEVIS PIN
- ③ CLEVIS PIN SPLIT RING
- ④ FORESTAY PIGTAIL
UPPER END = MARINE FORK
LOWER END = MARINE EYE
- ⑤ UPPER FURLING SWIVEL
- ⑥ UPPER FORESTAY EYE
- ⑦ JIB HEAD
- ⑧ JIB TACK/TIE
- ⑨ LOWER FORESTAY EYE
- ⑩ FURLING DRUM
- ⑪ STEMHEAD FITTING
- ⑫ TOPPING LIFT ATTACHMENT
PADEYE (PORT SIDE MAST)

NOTE: FORESTAY IS INTEGRATED WITHIN THE JIB LUFF

JIB FURLING:

1. JIB IS INSTALLED ROLLED UP
2. FURLING LINE IS EXTENDED ALL THE WAY
3. LEAD FURLING LINE THRU, "DECK TO COCKPIT CHASE TUBE"
4. THEN THRU JAM CLEAT
5. WHEN JIB IS EXTENDED, FURLING LINE RETRACTS INTO DRUM

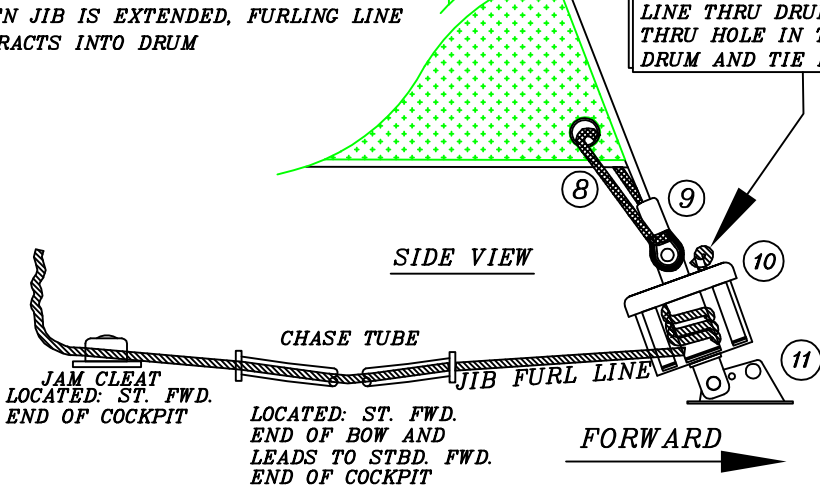

LEAD JIB FURL LINE
LINE THRU DRUM THEN UP
THRU HOLE IN TOP OF
DRUM AND TIE KNOT IN END.

JAM CLEAT
LOCATED: ST. FWD.
END OF COCKPIT

LOCATED: ST. FWD.
END OF BOW AND
LEADS TO STBD. FWD.
END OF COCKPIT

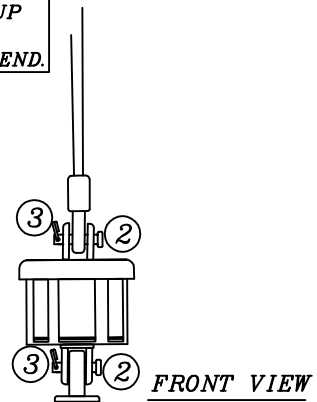

FORWARD

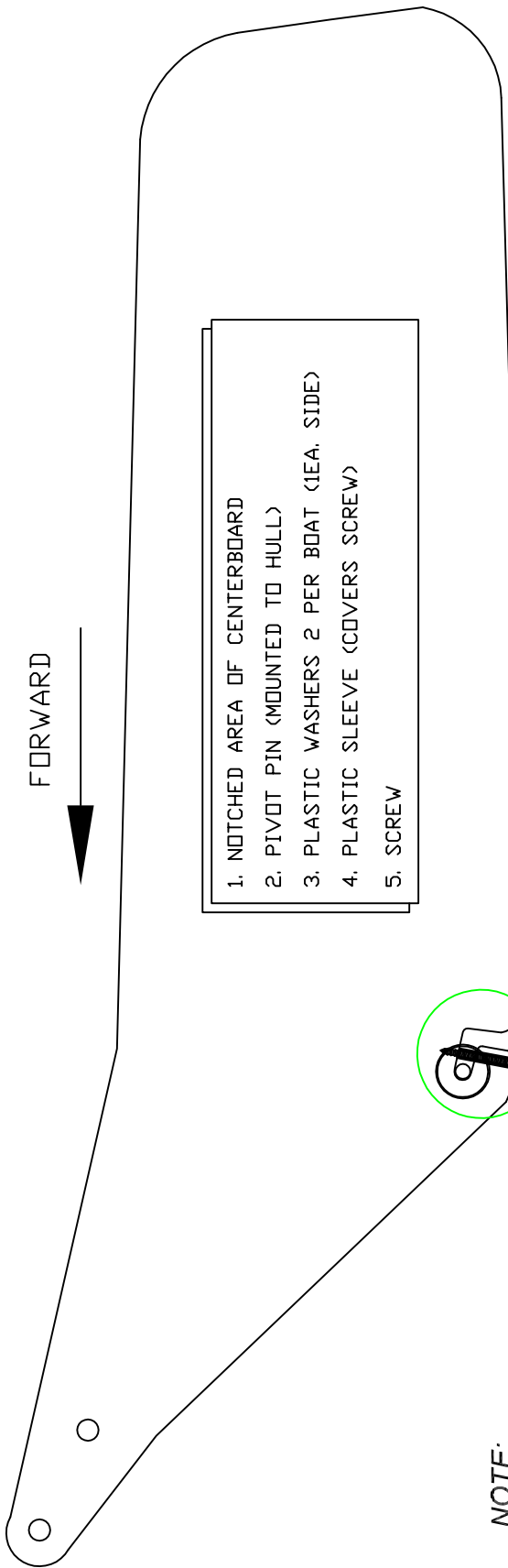

- 1. NOTCHED AREA OF CENTERBOARD
- 2. PIVOT PIN (MOUNTED TO HULL)
- 3. PLASTIC WASHERS 2 PER BOAT (LEA. SIDE)
- 4. PLASTIC SLEEVE (COVERS SCREW)
- 5. SCREW

LEADING EDGE, DOWN

NOTE:
INSPECT CENTERBOARD
ASSEMBLY ONCE A YEAR
MINIMUMLY

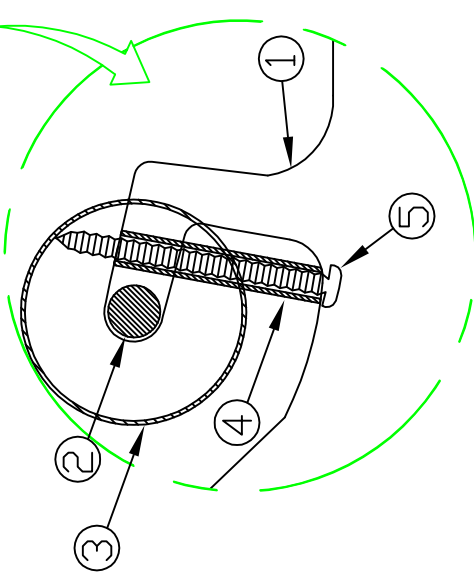

CENTERBOARD INSTALLATION INSTRUCTIONS:

- 1. REMOVE THE SCREW AND PLASTIC SLEEVE FWD. LOWER CENTERBOARD.
- 2. INSERT CENTERBOARD INTO THE TRUNK AND FIT NOTCH IN CENTERBOARD OVER THE PIVOT PIN INSIDE OF THE CENTERBOARD TRUNK. BE SURE THE CENTERBOARD IS IN BETWEEN THE PLASTIC WASHERS ON THE PIVOT PIN.
- 3. TURN THE BOAT ON ITS SIDE TO INSPECT THE INSTALLATION AND INSTALL THE SECURING SCREW AND THE PLASTIC SLEEVE. THIS WILL ENSURE THE CENTERBOARD IS SECURED ONTO THE PIVOT PIN.

SIDE VIEW OF INSTALLED CENTERBOARD

FORWARD
VIEW LOOKING DOWN

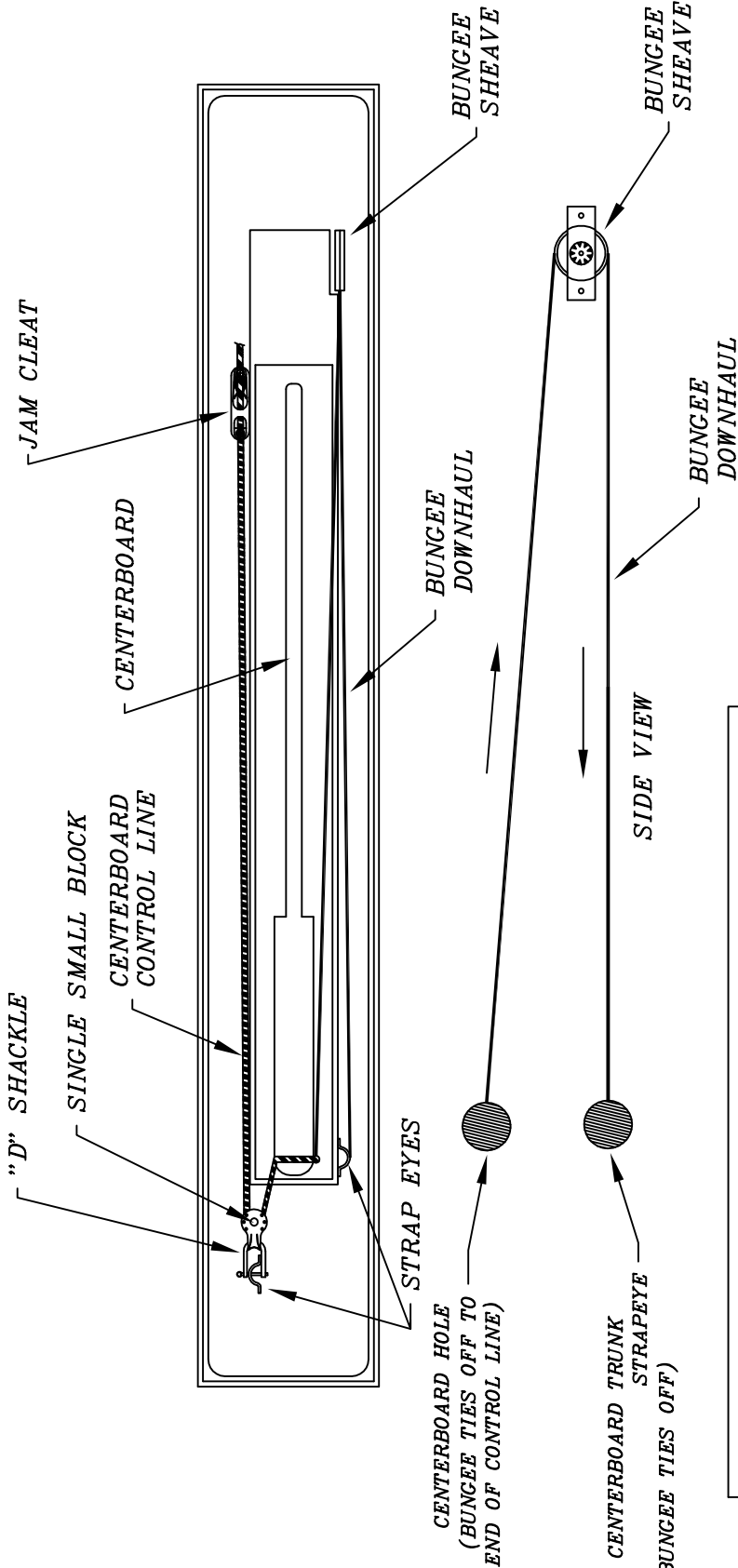

LINE INSTALLATION INSTRUCTIONS:

LEAD THE CENTERBOARD UPHAUL LINE THRU THE UPPER HOLE IN THE CENTERBOARD ON THE PORT SIDE. PULL THE LINE UNTIL THE JOINT WHERE THE BUNGEE AND THE LINE MEET RESTS AGAINST THE PORT SIDE CENTERBOARD. THEN TIE A KNOT IN THE LINE AS CLOSE TO THE CENTERBOARD AS POSSIBLE. LEAD THE LINE END THRU THE SMALL CENTERBOARD SHEAVE AND THEN AFT THRU THE JAM CLEAT. LEAD THE BUNGEE THRU CENTERBOARD TRUNK BUNGEE SHEAVE THEN FWD TO THE STRAP EYE AND SECURE.

CENTERBOARD OPERATIONS:

TO RAISE: PULL CONTROL LINE AFT AND SECURE IN JAM CLEAT.
TO LOWER: RELEASE LINE FROM JAM CLEAT, AND LET DOWN SLOWLY

- ① RUDDER
- ② RUDDER HEAD
- ③ DOWNHAUL LINE
- ④ UPHAUL LINE
- ⑤ RUDDER KEEPER PIN
- ⑥ TILLER ARM
- ⑦ TILLER ARM KEEPER PIN
- ⑧ JAM CLEAT
- ⑨ LINE BUSHINGS
- ⑩ PIN LOCK, PUSH FWD. PULL PIN UP

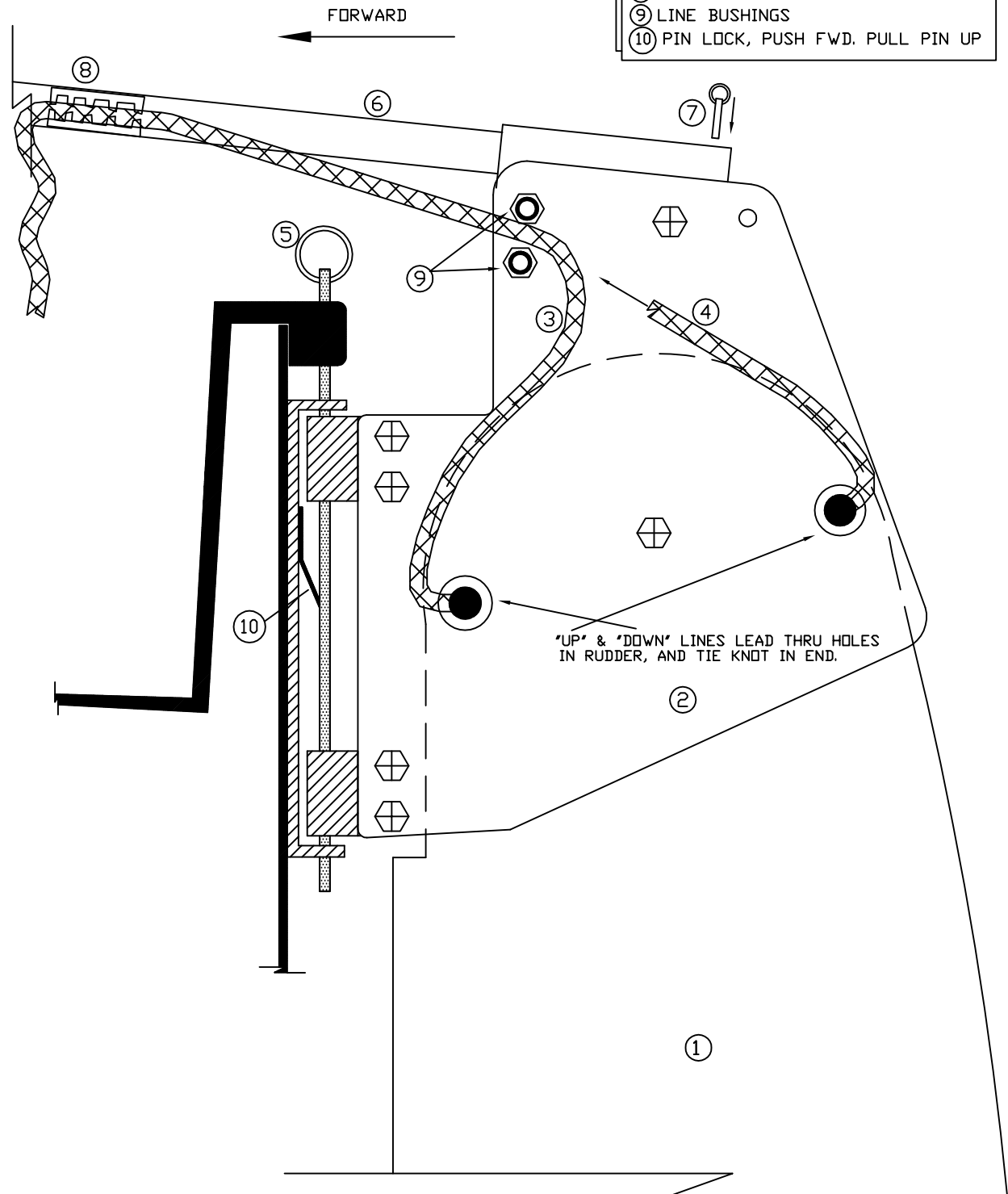

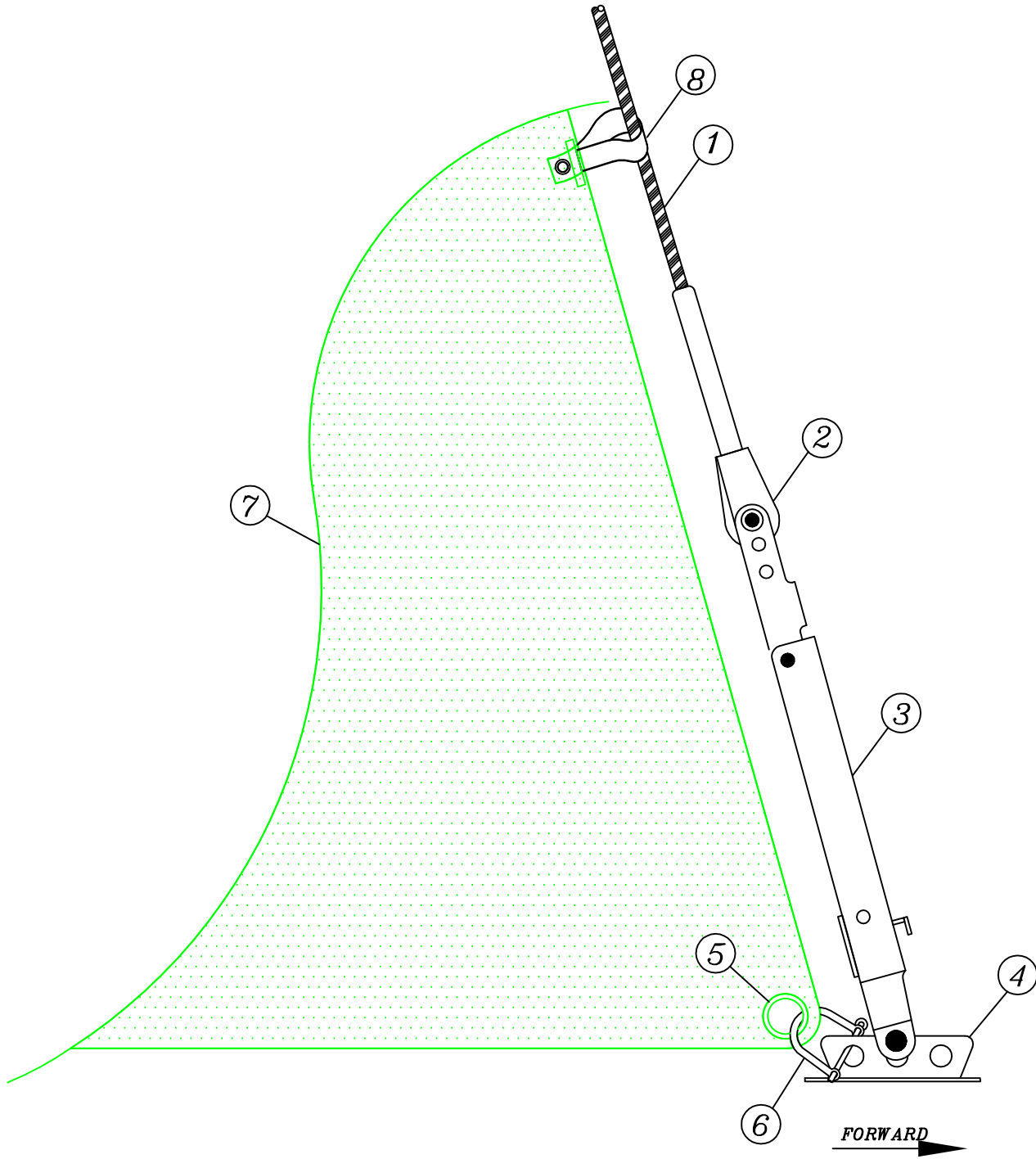

1. STANDARD FORESTAY RIGGING
2. STANDARD FORESTAY END (MARINE EYE)
3. TENSIONER ATTACHMENT
4. STEMHEAD FITTING
5. STANDARD JIB SAIL GROMMET
6. JIB SAIL TACK SHACKLE
7. STANDARD JIB SAIL
8. JIB SAIL HANK

JY15 Standing Rigging Specifications

FORESTAY (1) 1/8 1x19

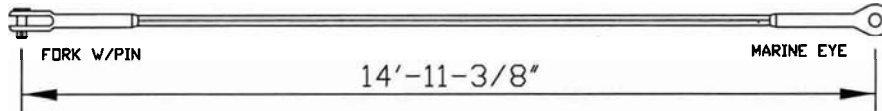

SHROUDS (2) 1/8 1x19

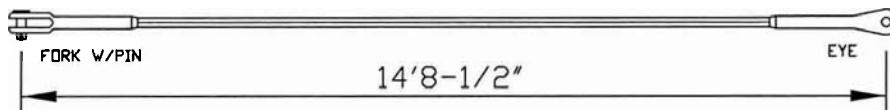

JIB FURLING TAIL 1/8 1X19

[WHEN REQUIRED]

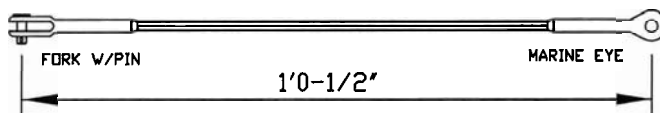

JY-15 LINE CHART

STANDARD LINE BAG							OPTIONAL
Main Halyard	Jib Halyard	Mainsheet	Jib Sheet	Vang	Traveler	Outhaul	2-1 Jib Sheet
1/4" @ 46'	1/4" @ 35'	3/8" @ 33'	3/8" @ 20'	1/4" @ 12'	1/4" @ 4'	3/16" @ 8'	1/4" @ 33'
<i>add shackle</i>	<i>add shackle</i>		<i>add vang block</i>				
46	35	33	20	12	4	8	33

Hiking Strap New Style:		Centerboard Lines:
	3 pieces of 3/16 LS x 3'	3/16" @ 6'
	3 pieces of 5/16" shockcord x 18"	5/16 shockcord @ 6.5'
	5' 4" (raw cut) hiking strap	
Hiking Strap Old Style:		Battens:
	2 crew @ 45" - grommet on each end	1 Long (47 1/2")
	1 skipper @ 58" - grommet on each end	2 Short (35 - 3/4")
	3 pieces 5/16" shockcord x 18"	2 Jib (12")
	5 pieces 3/16" x 3' LS	
Krylon 1501 or 2320 Glossy White		
	RF Line: 20' @ 4mm	
RF Pigtail:	12 1/2" x 1/8" wire (marine eye 1/4" ID one end, fork 3/16" ID other end)	
Spreader Clevis Pins: 3/16" dia x 5/8" grip		
C/B Flaps: 40 3/8"		

Warning

Your new JY is built using the ACP process. This is not a fiberglass boat!

The outer skin is a weatherable ABS plastic known as Luran S and is built by BASF. The outer plastic skin is approximately .170" thick.

To remove dirt or marks, start with soap and water. If this does not work, you can try denatured alcohol, and for really stubborn stains you can use mineral spirits.

NEVER LEAVE A RAG FULL OF MINERAL SPIRITS SITTING ON THE BOAT AS THIS WILL ATTACK THE PLASTIC AND VOID THE WARRANTY.

You can wax the surface if you would like, but be aware this will make the JY very slippery and you might fall out. For light scratches you can use a wax with a light compound or a mirror glaze which is available at any hardware store.

For more extensive repairs, see the repair section of your owner's manual or contact the factory.

When storing, please open the drain plugs so the boat can breathe. When trailing make sure the boat is well supported so as not to dent the hull.

Yes, you can use a boat cover as long as it is a light color (grey, light blue), and it is breathable.

JY15 Owner's Manual

Now we'll attach the main sheet swivel arm. Fasten the swivel arm to the base base plate on the centerboard trunk using the four screws provided. Make sure that the clam cleat is facing aft.

Place one of the washers over the swivel stud on the block.

Remove the clevis pins from the "U" adapter.

Place the "U" adapter over the swivel stud. Insert the clevis pin and split ring.

Place the other washer over the swivel stud on the now installed swivel arm base.

Place the spring on top of the washer and compress the spring so that you can line up the lower end of the "U" adapter with the swivel stud on the base. Slide in the remaining clevis pin and split ring.

Again, this is no easy task but it is doable.

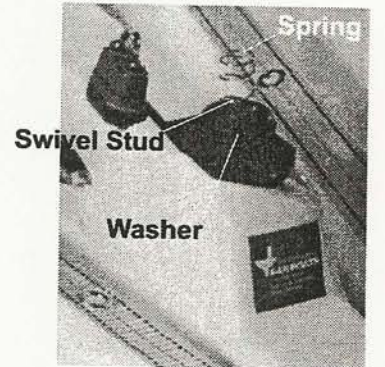
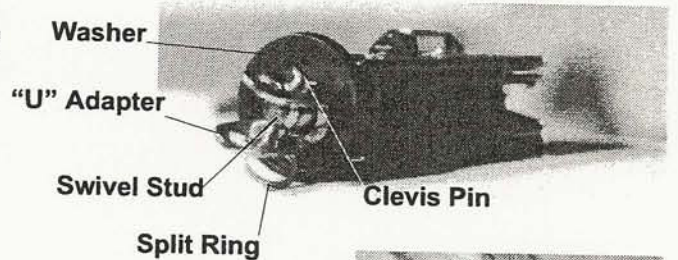
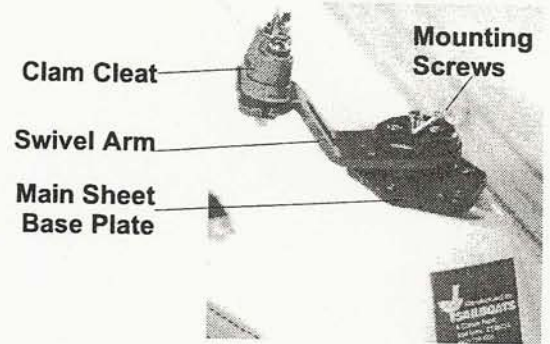
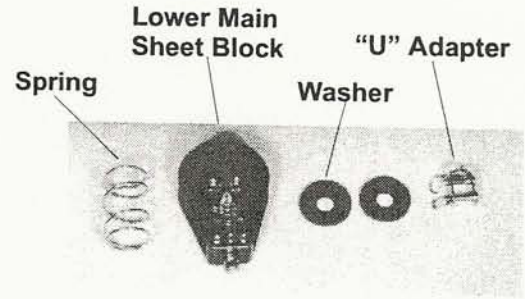

Installed Main Sheet Swivel Arm



JY15 Owner's Manual

Now we're ready to move onto the standing rigging. Start by attaching the shroud adjusters and headstay lever to the eyes on the ends of the shrouds and headstay.

The second hole from the top is a good place to start when setting up the shroud adjusters. Now attach the shrouds headstay to the tangs on the mast.

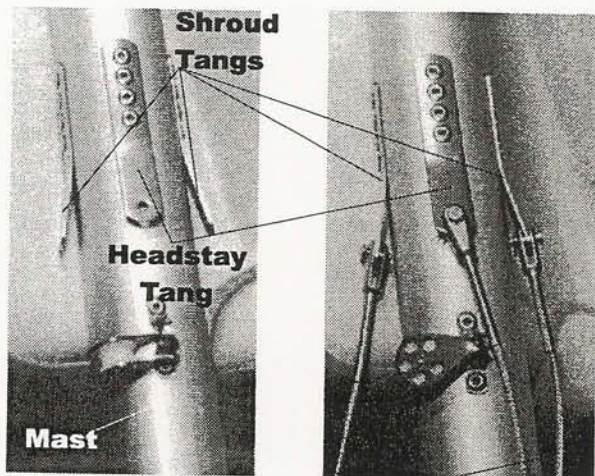
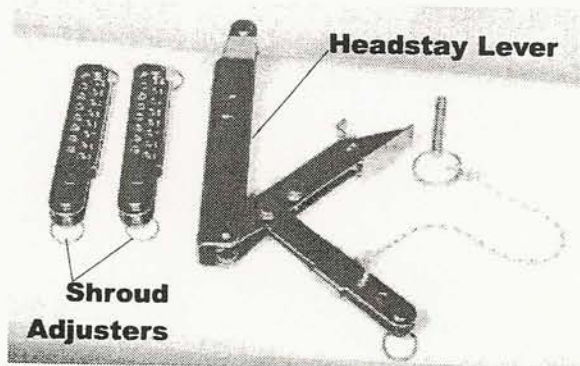
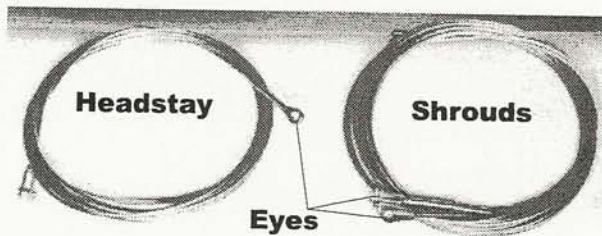

JY15 Owner's Manual

Now lead the main halyard over both blocks at the top of the mast from back to front. Make the halyard ends off on one of the cleats on the base of the mast.

Lead the jib halyard from the top of the jib halyard block on the front of the mast down to the cleat on the bottom of the mast and make the halyard ends off.

We're almost ready to step the mast. All that's left to do is the installation of the spreaders. Place spreaders in the sleeves on the appropriate side of the mast.

You can determine which is port and which is starboard by placing the screw head, side up, and aligning the holes in the spreader sleeve and the spreader itself.

Secure the spreaders to the sleeves using the pins and ring dings provided. You can release the shroud jaw by unscrewing the screw on the outboard end of the spreader.

Slide the shroud into the jaw, reinsert the jaw into the spreader and tighten the screw. The shroud should now be held in place on the outboard end of the spreader.

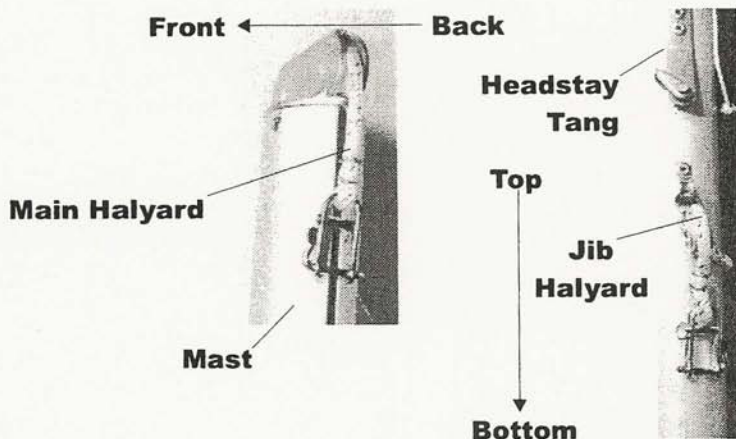

Note: It's always a good idea to tape all ring dings, pins and screws after installation.

J/15 Owner's Manual

To step the mast, lower the mast through the hole in the deck and seat the base on the mast step. The mast will stand, unsupported, temporarily.

Attach the shrouds to the u bolt chain plates, open side facing aft. The second hole from the top is a good place to start by way of adjustment.

With the lever open attach the headstay to the forward hole on the stemhead fitting. Close the lever and secure with the fast pin provided.

The lever should be firm but not difficult to close. Remember to release tension on the headstay then you're not sailing or if the rigging is to be left standing in storage.

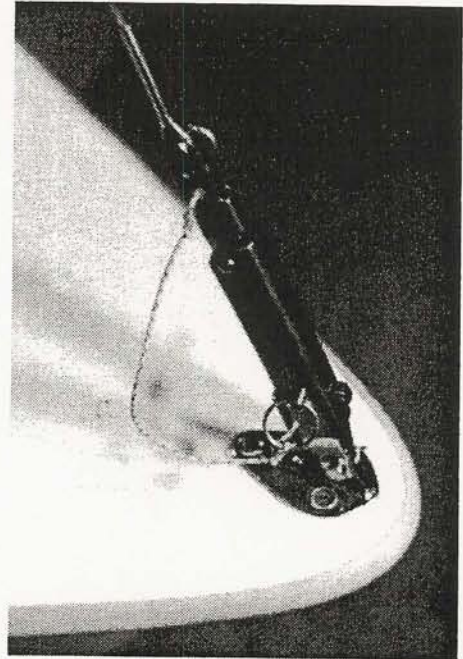
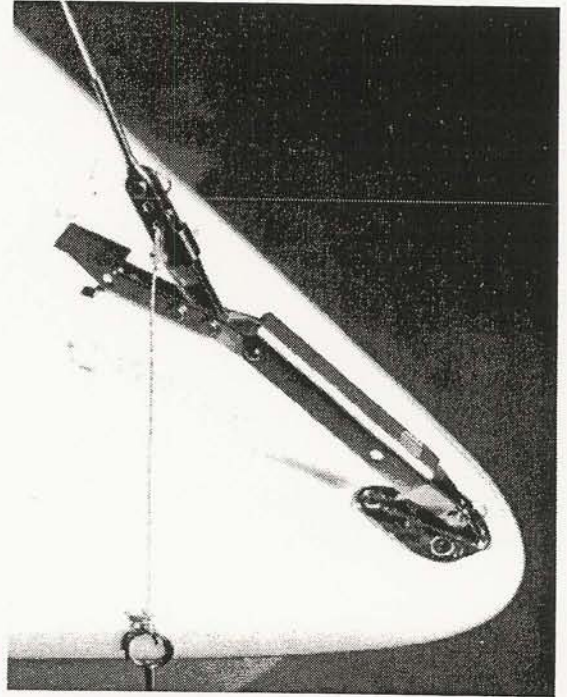

2015 Owner's Manual

Use the rudder pin to attach the rudder to the boat.

The tiller extension mounts onto the tiller by sliding it into the plastic clip and then sliding the plastic cover down over the clip.

Some people wrap tape around the clip and tiller to prevent the extension from coming off.

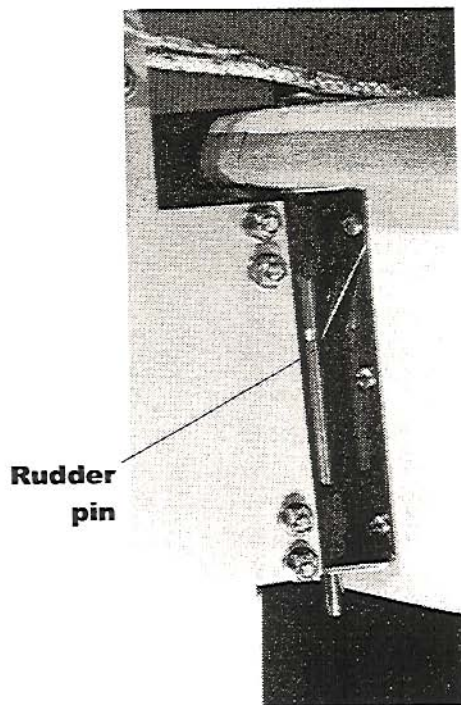

JY15 Owner's Manual

Now you need to install the mast partners. The partners are use to hold the mast snugly in place and provide unity between the rig and the hull. Should you need to shape a partner this can easily be accomplished with sandpaper. Be careful though, not to remove too much material because it will allow the mast to move.

Install the U shaped partner with the opening facing either forward or aft. Depending on your tuning needs you'll either want to place the T shaped partner behind the U to depower the main or at the opening of the U to center the mast for more power.

Failure to install the mast partners can lead to structural damage to the hull and deck and can also decrease the performance of the boat.

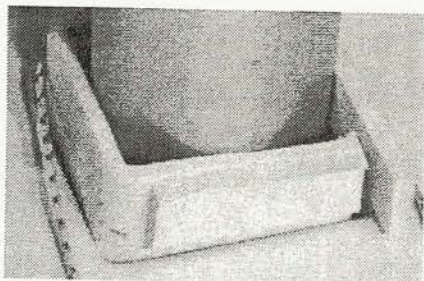

JY15 Owner's Manual

Now attach the two main sheet blocks to the boom. Attach the block with the becket to the bail on the aft end of the boom and the single block to the bail in the middle of the boom. Both shackles should be attached through the block straps to provide for a fore and aft lead through the blocks.

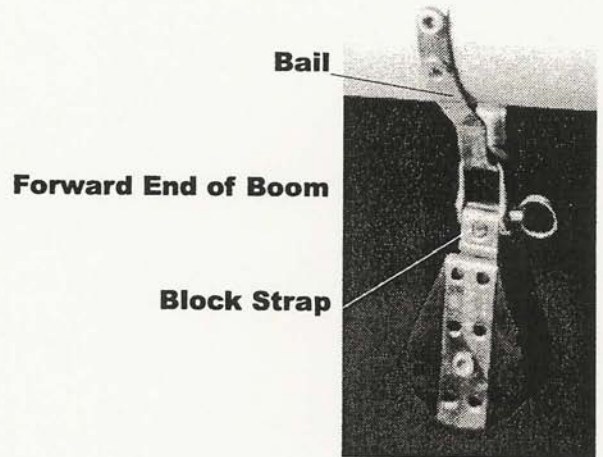
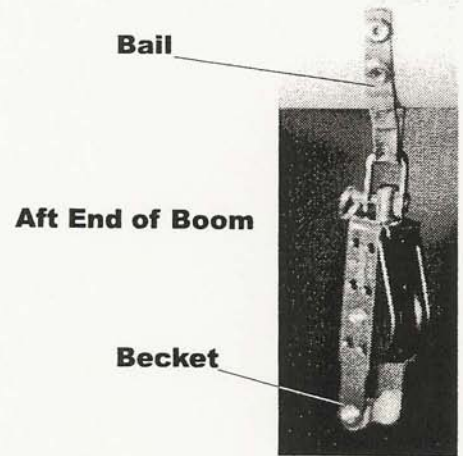

Next, attach the outhaul micro block to the eyestay on the aft end of the boom.

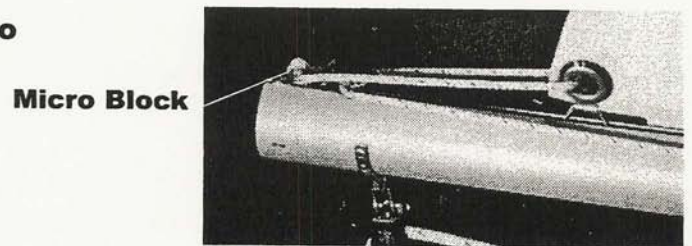

Attach the boom to the mast at the gooseneck.

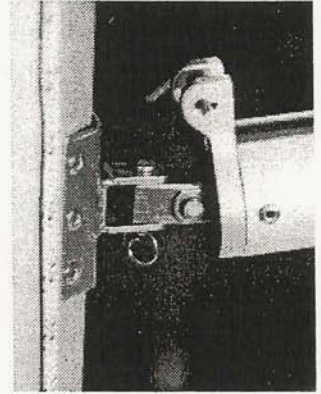

Boom held up by mainsheet

Lead the mainsheet as shown. Be sure the swivel block ratchets when the sheet is trimmed.

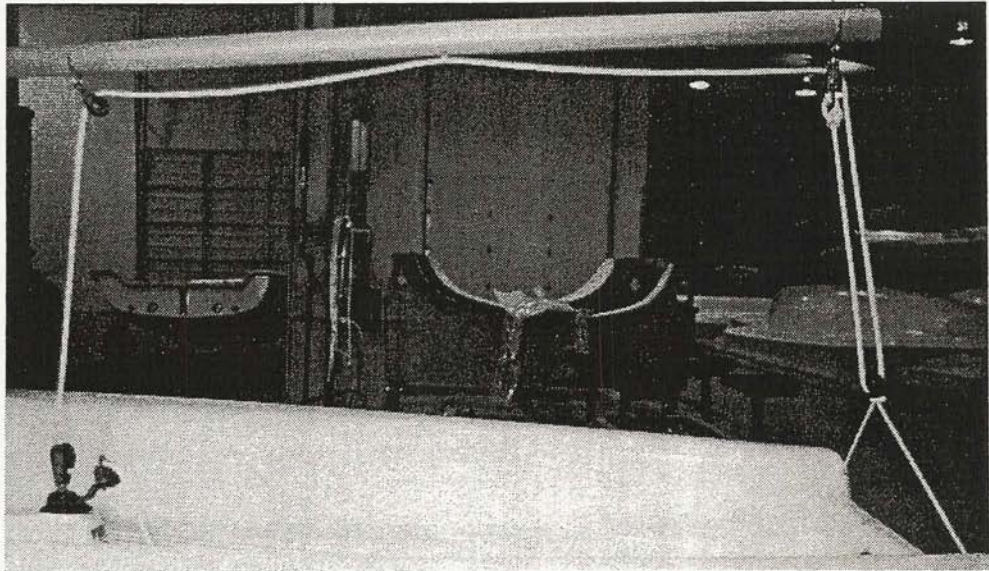

JY15 Owner's Manual

Attach the boom vang double block to the forward bail on the boom with a twist shackle.

Twist Shackle

Vang Double Block



Attach the fiddle block to the bail on the mast with a twist shackle...V jam down.

Some sailors like the system reversed with the fiddle block on the boom...either way is fine.

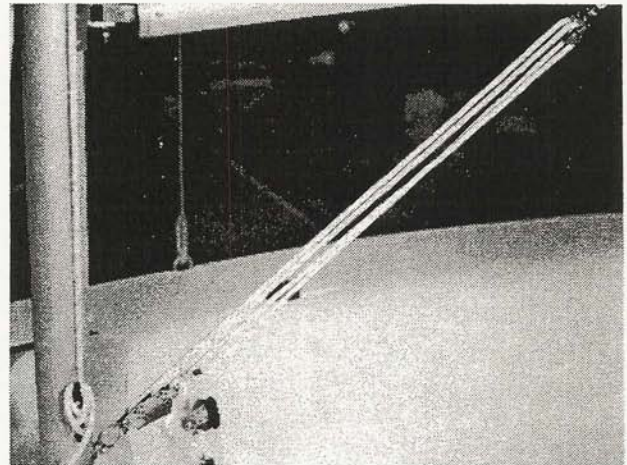

JY15 Owner's Manual

Attach the mainsail tack to the boom with the pin.



Insert the car at the mainsail clew into the groove on the boom and lead it aft so that the foot rope is threaded into the groove as well.

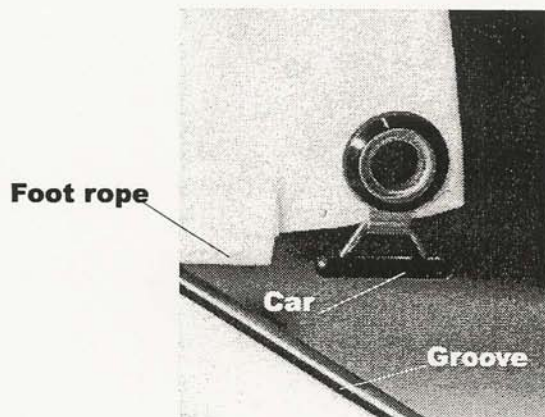

Now, install the top batten in the mainsail. The top batten will stick out about 1.5". Lightly tension the velcro closing strap to secure the batten. Secure the outhaul as shown for a 2:1 purchase.

Knotted end through eyestrap



2215 Owner's Manual

Attach the main halyard to the mainsail and raise the sail making sure that the luff rope threads into the groove in the mast.

Main halyard

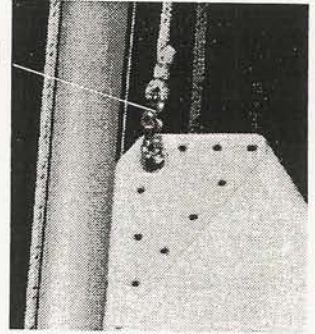

Attach the tack shackle to the jib. This is a captive shackle and can be left in place permanently. Attach the shackle to the hole in the stemhead fitting to secure the jib.

Tack shackle

Stemhead fitting

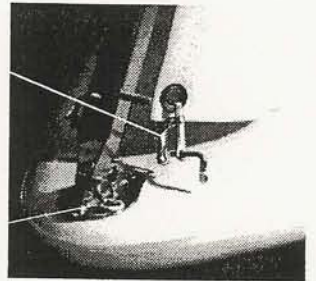

Attach the jib halyard to the jib and raise...clipping the jib hanks onto the headstay as you go.

Jib Halyard

Headstay

Jib hank

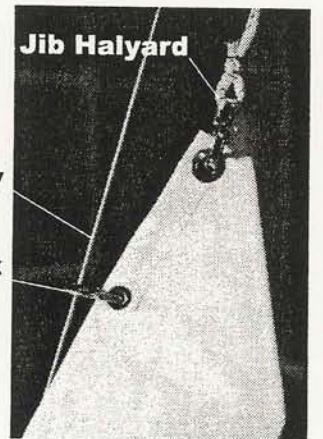

JY15 Owner's Manual

Hiking strap installation. The JY15 comes with two 60 inch long hiking straps with grommets on each end. You also get 4 pieces of 3/16 inch line and two pieces of shock cord.

To install the hiking straps, tie one 3/16 inch piece of line to each end of the hiking strap through the grommet.

Attach one end of the strap to the eyestraps on the floor in the middle of the boat at the aft end of the centerboard trunk. Attach the other end to the eyestraps closest to the mast step.

Tie the shock cord to the grommet on the forward end of the hiking strap and tie the other end to the eyestraps located below the one used for the jib block.

Some sailors tie the shock cord to the eyestraps for the jib block. This lifts the hiking strap a bit higher.

Hiking straps need to be adjusted for every sailor. Taller sailors will like a tighter strap. Some sailors even attach a shock cord from one eyestraps, around the mast, to the other eyestraps. This lifts the strap even higher.

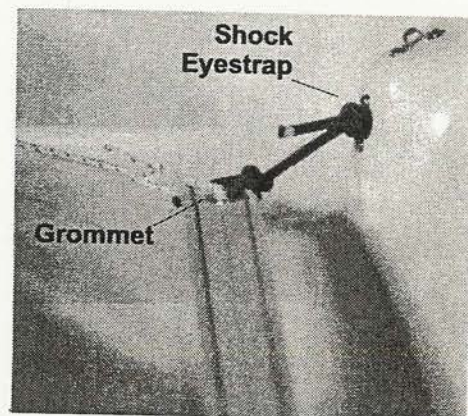
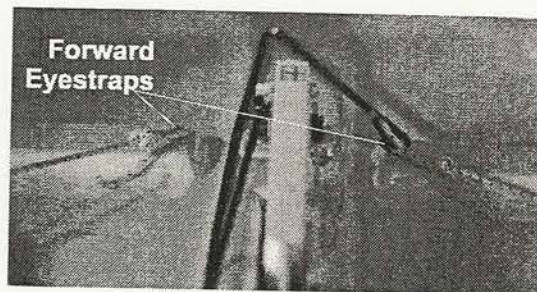
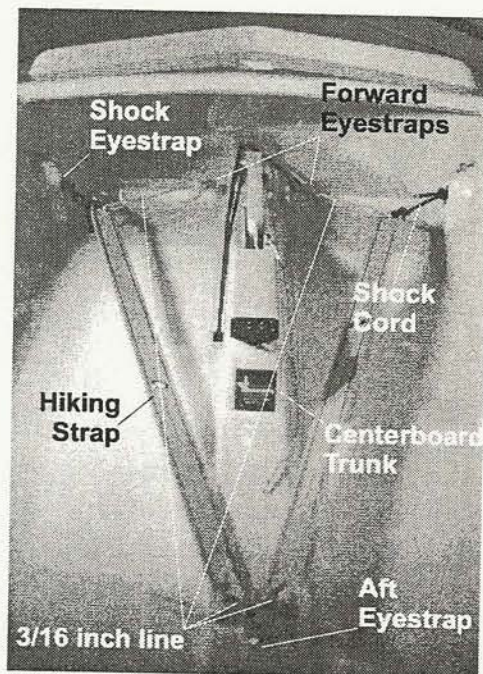

JY15 Owner's Manual

Now we'll attach the traveler. To attach the traveler block fold the traveler line in half and feed the loop through the bail on the block.

Pull the loose ends through the loop keeping them together to center the block on the line.

Now lead the loose ends through the holes in the rolled edge of the transom and tie a figure eight knot in each end.

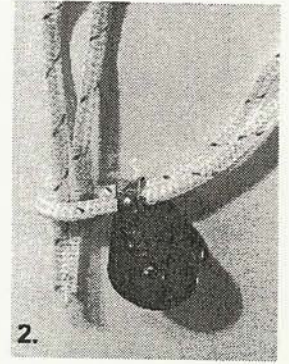
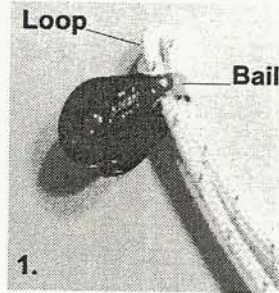

Now we'll attach the jib sheet blocks to the upper eyestraps on the mounting pods on each side tank.

Slip the shackle through the eyestraps with its jaws facing up. Place a spring over the shackle and align the holes on the swivel stud on the block with the holes in the shackle.

Press the block down onto the spring and insert the clevis pin through the shackle and stud and insert the split ring.

This procedure isn't easy but it is possible.

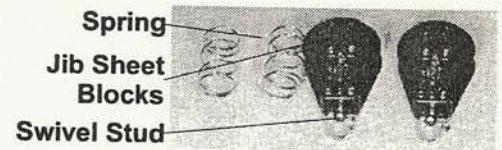
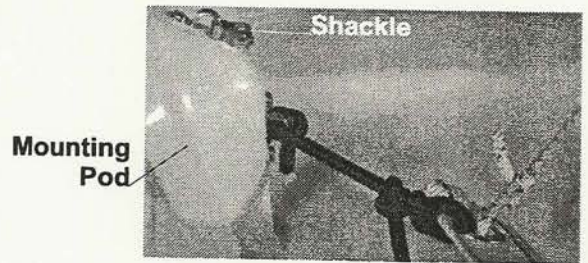
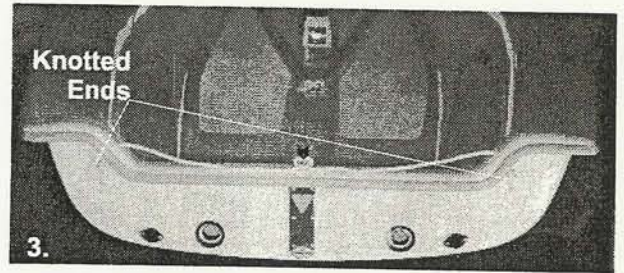

Installed
Jib Sheet
Block

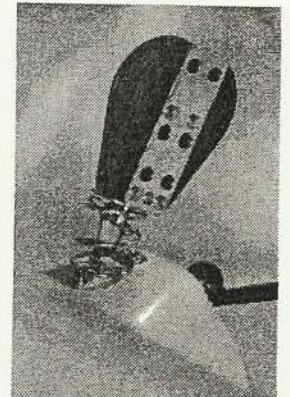

JY15 Rigging Inst.

JY15 Owner's Manual

Attach the jib sheets to the jib. The jib sheets are a single line doubled. The loop is passed through the clew cringle and over the line ends...draw through.

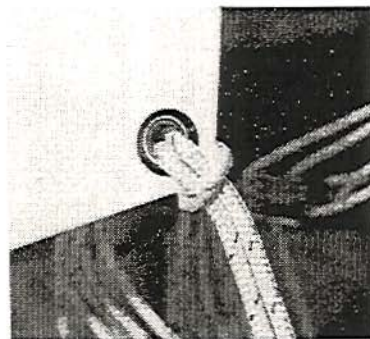

Now you're ready to attach the rudder. The rudder and tiller are two separate units. The rudder has an uphaul and a downhaul which lead over the plastic bushing and cleat on the side of the tiller. Both lines share the same cleat.

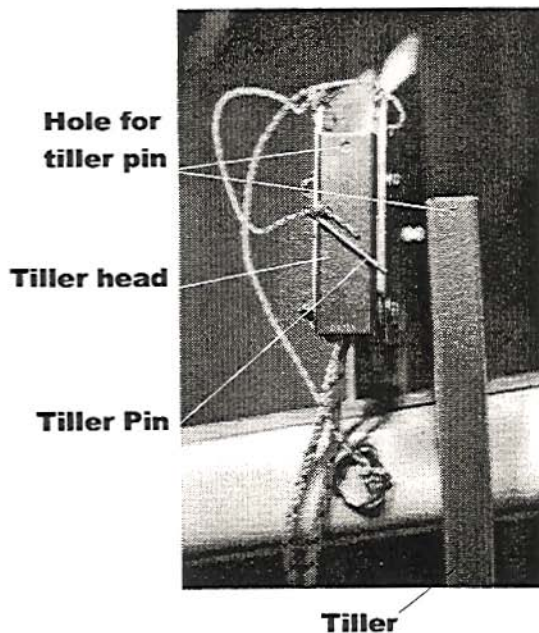

Slide the tiller into the tiller head and hold it in place with the tiller pin.

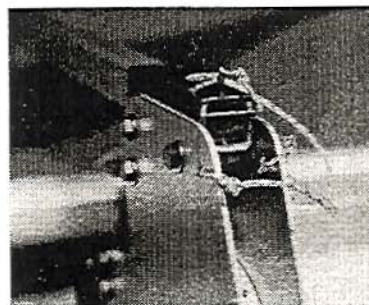

JY15 SAIL NUMBER APPLICATION

Preparation: Find a clean working surface large enough to lay a section of the sail flat. A smooth floor or large table is fine. You will need a pencil, ruler, and scissors.

Sail Numbers to Apply: There is a serial number molded into the transom of your boat. The fourth through seventh digits represent your hull and sail number.

Example: JYA 00567 J089. The sail number is 567

Location of Numbers: (Starboard side of sail)
the United States Yacht Racing Union (USYRU) specifies that the sail number will appear on both sides of the sail at different heights, those on the starboard side (right) being uppermost. To find the starboard side, place the sail on the floor with the sail logo appearing in the lower right corner.

All numbers are cut out of the digit eight as shown in figure #1.

Starboard numbers are placed immediately below the middle batten pocket. Measure in 4" from the edge of the sail for placement of your first number. The space between digits should be 2" (see figure #2).

Application: Peel about 2" of protective paper from the top edge of the number and fold it back. Carefully align this edge with the bottom edge of the batten pocket, spacing it properly 4" in from sail edge. Smooth out the peeled portion by pressing firmly with your fingers. You can now continue peeling the protective paper upward along the full width of the number. Rub down the number hard and be sure there are no wrinkles or bubbles.

Apply the other digits leaving a space of 2" between numbers.

Location of Numbers: (Port Side of sail)
Turn the sail over and flatten. The sail logo should now appear on the lower left of the sail. Align the numbers immediately above the 2nd seam below the middle batten. Again, measure in 4" from the edge of the sail and place your last digit. This time, peel back the protective paper from the bottom of the number and align along the seam. (See figure #3).

IMPORTANT: ALLOW ABOUT 24 HOURS FOR ADHESIVES
TO DRY BEFORE USING YOUR SAILS.

JY15 Owner's Manual

0 1 2 3 4 5 6 7 8 9

Starboard Side

Port Side

