

33

SCHEMATICS

12/1/2005

INDEX

PAGE

3. *DC Panel*
4. *DC Panel Schematic*
5. *DC Panel Connectors*
7. *AC Panel - Single*
8. *AC Panel Schematic – Single*
9. *Misc. Harness Adapters*
10. *AC Panel – Dual*
11. *AC Panel Schematic - Dual*
12. *Hull Harness*
13. *Hull Harness Connectors*
14. *Hull Harness Wire List*
15. *Deck Harness*
16. *Deck Harness Connectors*
17. *Deck Harness Wire List*
18. *AC Wire Kit*
19. *Misc. Wire Kits*
20. *TV-DVD Option Wire Kit*
21. *Engine Panel Wiring Schematic*
22. *Auto Fire Ext. System Schematic*
23. *High Water Pump Option Schematic*
24. *Lighting Layout*

LIST OF DETAILS TO BE INCLUDED WITH PANEL.

- 20 AMP RESET WIRED TO A HOT BUS THEN TO 12VDC OUTLETS THEN TO PLUG
- TWO 12VDC OUTLETS.
- WIRE PANEL WITH PLUGS.
- PREWIRE PANEL FOR OPTIONAL EQUIPMENT.
- HINGE WITH MOUNTING SCREW HOLES
- BACK LIGHTING OF LABELS AND VOLT METER.
- SUPPLY WIRES FOR BACK LIGHTING AC SUB PANEL,
USE SPADE CONNECTORS FOR EASY CONNECTIONS.
- WIRE MACERATOR TOGGLE SWITCH TO MACERATOR BREAKER.
- 5 AMP RESET WIRED HOT TO THE BILGE CIRCUIT FOR CO ALARMS.

BREAKER LIST TO BE SUPPLIED WITH PANEL.

- CABIN LIGHTS :20 AMPS
- LP GAS : 5 AMPS
- REFRIGERATOR :15 AMPS
- TANK INDICATOR : 5 AMPS
- WATER PUMP :10 AMPS
- SUMP PUMP :10 AMPS
- BLOWER :10 AMPS
- STEREO :10 AMPS
- MACERATOR :20 AMPS
- ANCHOR LIGHT : 5 AMPS
- STEAMING LIGHT : 5 AMPS
- RUNNING LIGHTS :10 AMPS
- VHF RADIO :10 AMPS
- INSTRUMENTS : 5 AMPS
- TV/DVD :NONE
- HEAD :NONE
- SPARE :NONE

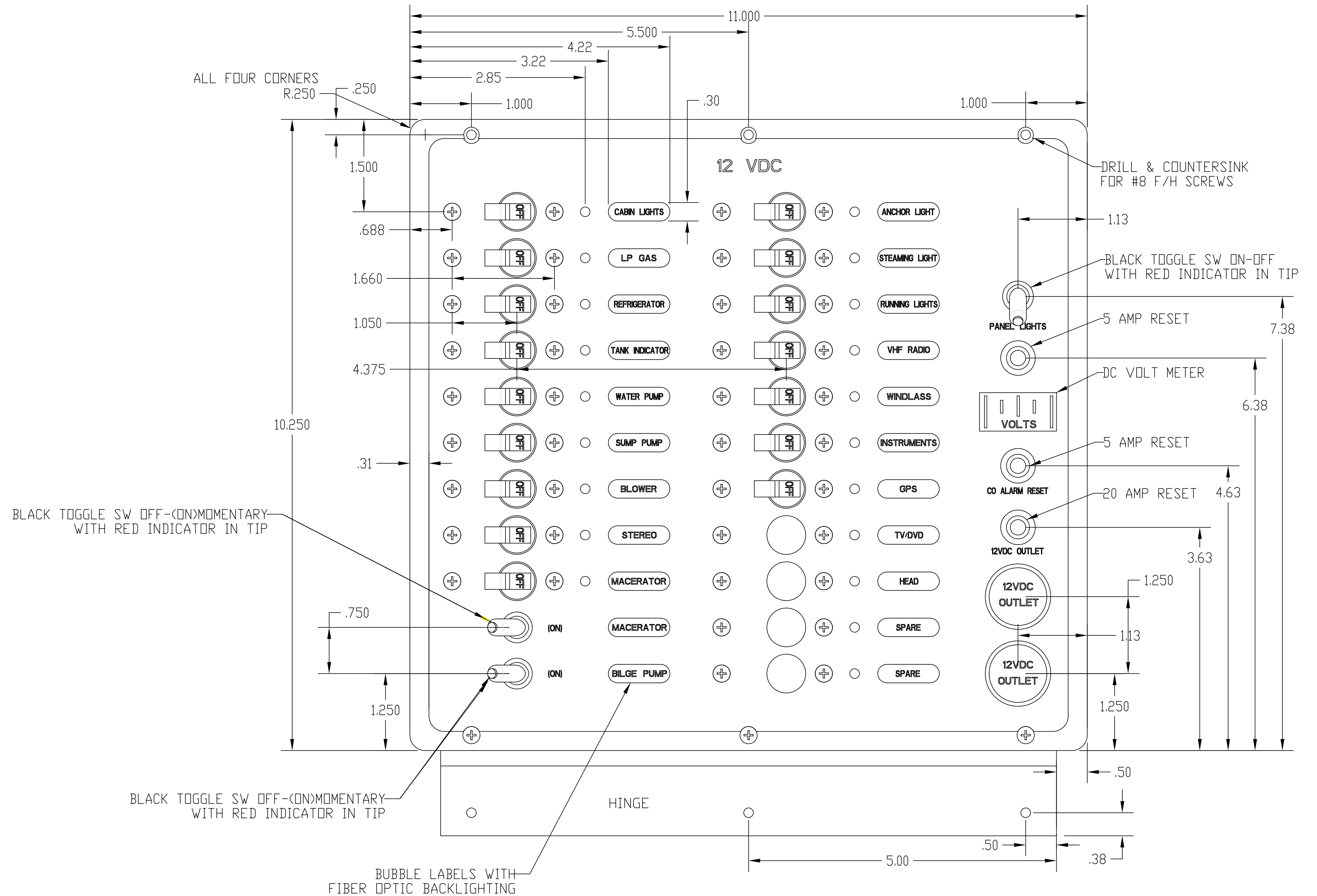

- NOTE:
- PANEL MATERIAL - 1/8" ALUMINUM
 - PANEL COLOR & FINISH - FLAT CARBON BLACK WITH GLOSSY BLACK BORDER
 - BACK LIGHTING COLOR - BLUE
 - BREAKER INDICATOR LIGHTS - RED LED
 - BREAKER HANDLE COLOR - BLACK
 - TOGGLE SWITCHES INDICATORS - RED
 - ADD HINGE TO BOTTOM OF PANEL.
 - SEE ELECTRICAL SCHEMATIC FOR BACKSIDE

SYMBOL	REVISIONS	DATE	ENG
A	DELETE WIRE #7 OFF PANEL	8/14/03	JLK
B	UPDATE WATER&SUMP PUMP BREAKERS	1/23/04	JLK

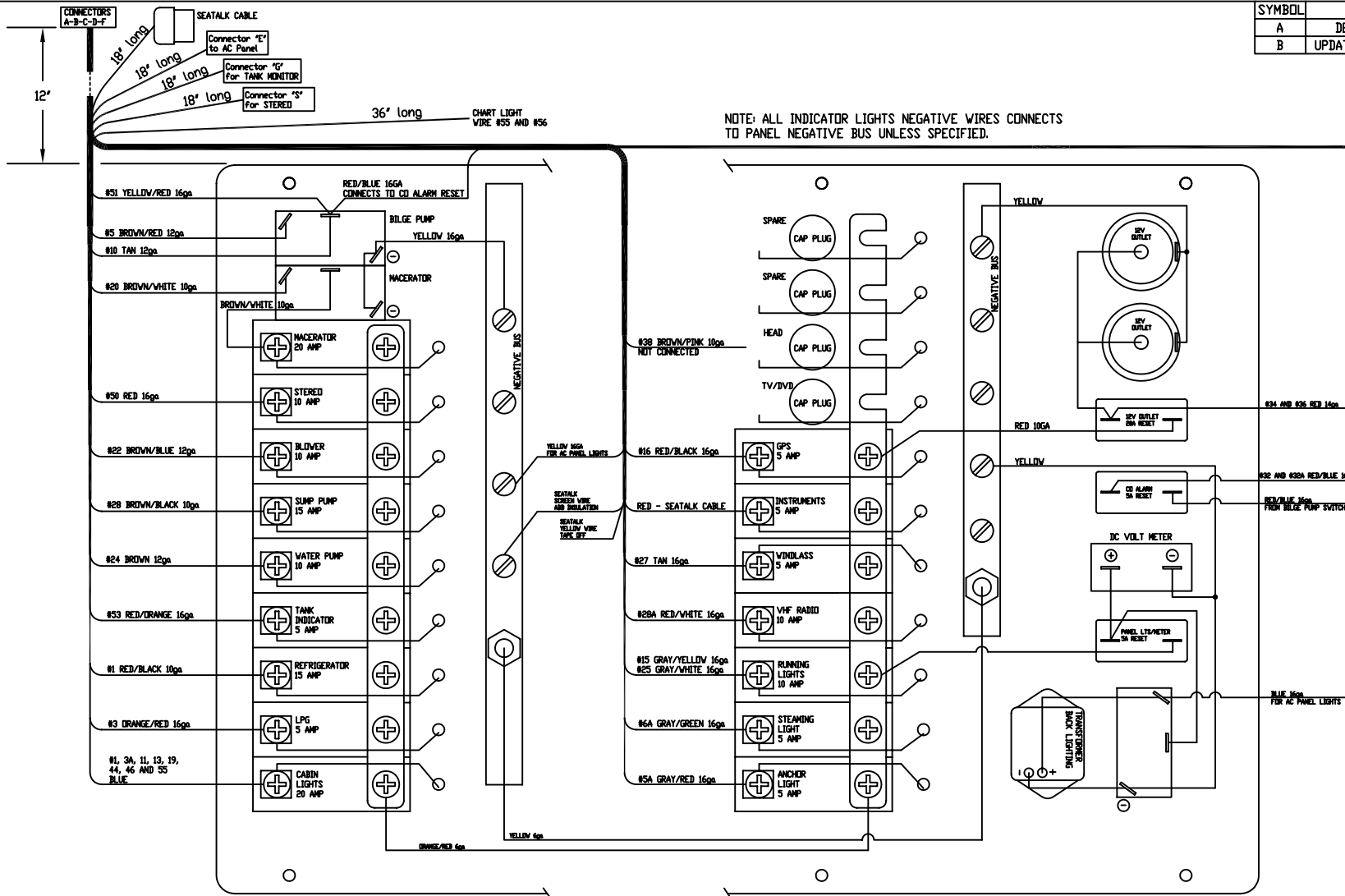

PROPRIETARY INFORMATION THIS DRAWING CONTAINS INFORMATION FOR WHICH HUNTER MARINE CORPORATION HAS PROPRIETARY RIGHTS



DRAWING TITLE: DC PANEL SCHEMATIC		DRAWN BY: JLK		DATE: 12-Aug-03		SHEET 1		OF 1	
SCALE: 0.625		HUNTER PART NO. TBD		REVISION -		DRAW # - - - -			

CHECKED

DC PANEL CONNECTORS for 306, 326, 33 & 356

All connectors to be female pins with male connectors.

REV. E
11/20/2003

CONN. A	WIRE# (HULL)	WIRED TO ON PANEL	CONN. TYPE
1	#34, 14ga Red, 12V OUTLET	12VDC OUTLET RESET	Deutsch - DTP Series - 4pin
2	#36, 14ga Red, 12V OUTLET	12VDC OUTLET RESET	
3	#5, 12ga Brown/Red, BILGE MANUAL	BILGE TOGGLE SWITCH	
4	#10, 12ga Tan, BILGE POWER	BILGE TOGGLE SWITCH	

CONN. B	WIRE# (HULL)	WIRED TO ON PANEL	CONN. TYPE
1	#44, 14ga Blue, CABIN LIGHTS	CABIN LIGHT BREAKER	Deutsch - DT Series - 6 pin
2	#46, 14ga Blue, CABIN LIGHTS	CABIN LIGHT BREAKER	
3	#3, 16ga Orange/Red, LPG	LP GAS BREAKER	
4	#32, 16ga Red/Blue, CO ALARM	CO ALARM RESET	
5	#32A, 16ga Red/Blue, CO ALARM	CO ALARM RESET	
6			

CONN. C	WIRE# (HULL)	WIRED TO ON PANEL	CONN. TYPE
1	#20, 10ga Brown/White, MACERATOR	MACERATOR BREAKER	Deutsch - DTP Series - 4pin
2	#24, 12ga Brown, WATER PUMP	WATER PUMP BREAKER	
3	#28, 12ga Brown/Black, SUMP PUMP	SUMP PUMP BREAKER	
4	#22, 12ga Brown/Blue, BLOWER	BLOWER BREAKER	

CONN. D	WIRE# (HULL)	WIRED TO ON PANEL	CONN. TYPE
1	#1, 10ga Red/Black, REFRIGERATOR	REFRIGERATOR BREAKER	Deutsch - DTP Series - 2pin
2	#38, 10ga Brown/Pink, HEAD	branches to HEAD location on panel, but not connected	

CONN. E	WIRE# (PANEL TO PANEL)	WIRED TO ON PANEL	CONN. TYPE
1	16ga Blue, PANEL LIGHTS	PANEL LIGHT BREAKER	Deutsch - DT Series - 2 pin
2	16ga Yellow, PANEL LIGHTS (-)	DC NEGATIVE BUS	

CONN. F	WIRE# (DECK)	WIRED TO ON PANEL	CONN. TYPE
1	#1, 16ga Blue, MAIN LIGHTS	CABIN LIGHT BREAKER	Deutsch - DT Series - 12 pin
2	#3A, 16ga Blue, FORWARD LIGHTS	CABIN LIGHT BREAKER	
3	#5A, 14ga Gray/Red, ANCHOR LIGHT	ANCHOR LIGHT BREAKER	
4	#6A, 14ga Gray/Green, STEAMING LIGHT	STEAMING LIGHT BREAKER	
5	#13, 16ga Blue, PORT AFT LIGHTS	CABIN LIGHT BREAKER	
6	#28A, 16ga Red/White, VHF PWR	VHF RADIO BREAKER	
7	#11, 16ga Blue, STBD LIGHTS	CABIN LIGHT BREAKER	
8	#15, 16ga Gray/Yellow, STERN LIGHT	RUNNING LIGHTS BREAKER	
9	#19, 16ga Blue/White, ARCH LIGHT	CABIN LIGHT BREAKER	
10	#25, 16ga Gray/White, BOW LIGHT	RUNNING LIGHTS BREAKER	
11	#27, 16ga Tan, WINDLASS	WINDLASS BREAKER	
12	#16, 16ga Red/Black, GPS	GPS BREAKER	

CONN. G	WIRE# (TO TANK MONITOR)	WIRED TO ON PANEL OR OTHER	CONN. TYPE
1	#53, 16ga Red/Orange, TANK MONITOR (+)	TANK DISPLAY BREAKER	Deutsch - DT Series - 2 pin
2	#54, 16ga Yellow, TANK MONITOR (-)	DC NEGATIVE BUS	

CONN. S	WIRE# (STEREO PWR)	WIRED TO ON PANEL	CONN. TYPE
1	#50, 16ga Red, STEREO PWR	STEREO BREAKER	Deutsch - DT Series - 3 pin
2	#51, 16ga Yellow/Red, STEREO MEMORY	center post bilge toggle switch with #5 brown/red wire	
3	#52, 16ga Yellow, STEREO (-)	DC NEGATIVE BUS	

	WIRE#	WIRED TO ON PANEL	
	#55, 16ga Blue, CHART LIGHT (+)	CABIN LIGHT BREAKER, 66" total length	blue butt splice
	#56, 16ga Yellow, CHART LIGHT (-)	DC NEGATIVE BUS, 66" total length	blue butt splice

NOTE:

1. PANEL MATERIAL - 1/8" ALUMINUM
2. PANEL COLOR & FINISH - FLAT CARBON BLACK WITH GLOSSY BLACK BORDER
3. BACK LIGHTING COLOR - BLUE
4. AC MAIN INDICATOR - GREEN USING NEON BULB
REVERSE POLARITY INDICATOR - RED USING NEON BULB
BREAKER INDICATOR LIGHTS - RED LED
5. BREAKER HANDLE COLOR - BLACK
6. ADD HINGE TO BOTTOM OF PANEL.
7. SEE ELECTRICAL SCHEMATIC FOR BACKSIDE

BREAKER LIST TO BE SUPPLIED WITH PANEL FOR 120V-60 HERTZ VERSION.

- AC MAIN :30 AMP, DOUBLE
- OUTLETS :15 AMP
- MICROWAVE :15 AMP
- BATTERY CHARGER :15 AMP
- WATER HEATER :15 AMP
- SPARE :NONE

BREAKER LIST TO BE SUPPLIED WITH PANEL FOR 230V-50 HERTZ VERSION

- AC MAIN :15 AMP, DOUBLE
- OUTLETS :10 AMP
- MICROWAVE :10 AMP
- BATTERY CHARGER :10 AMP
- WATER HEATER :10 AMP

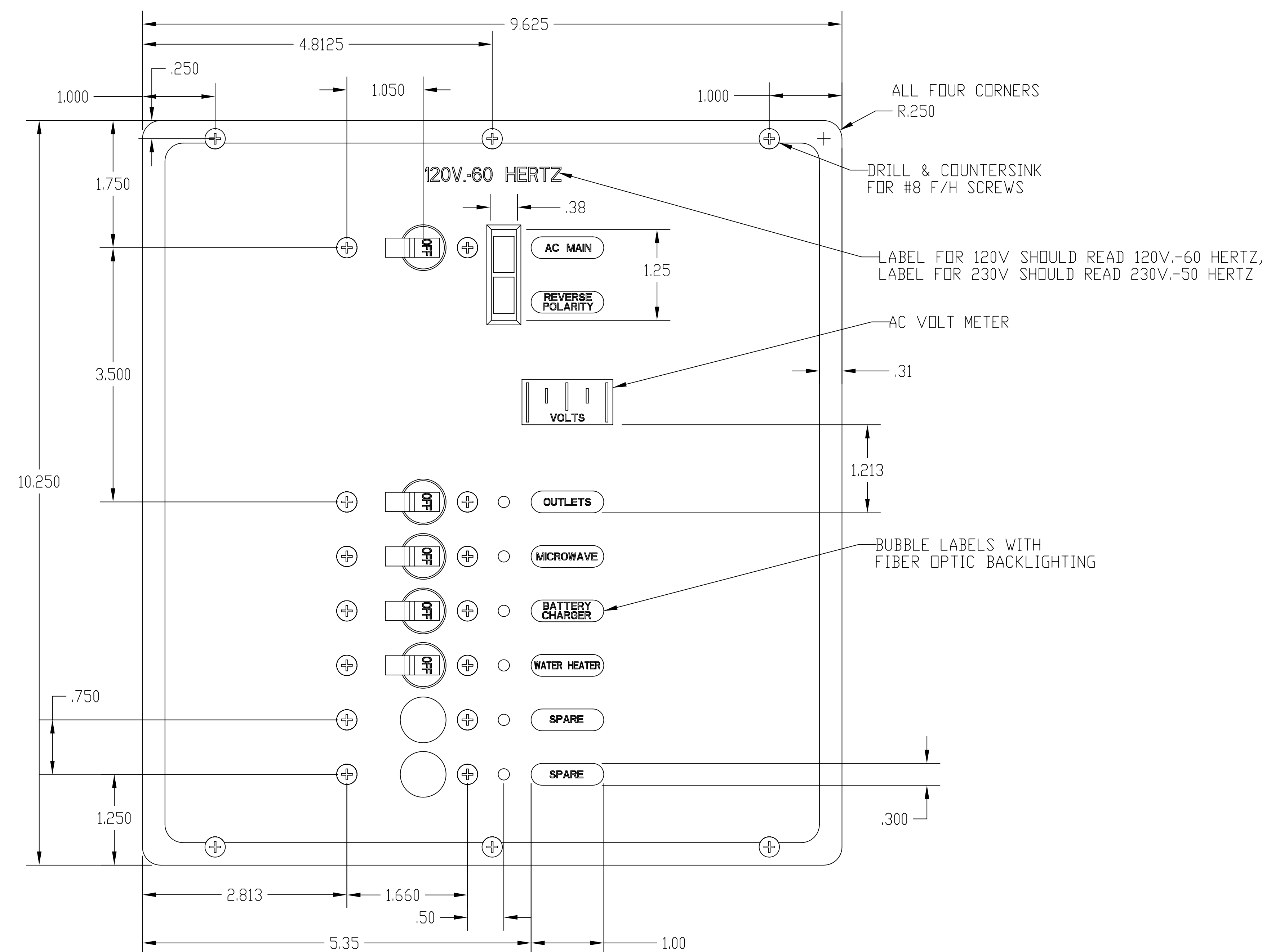

SYMBOL	REVISIONS	DATE	ENG

LEGEND

- = 8ga wire
- = 18-14ga wire
- 10ga marked as shown.

NOTE: ALL INDICATOR LIGHTS NEUTRAL WIRES CONNECTS TO LINE 1 NEUTRAL BUS UNLESS SPECIFIED.

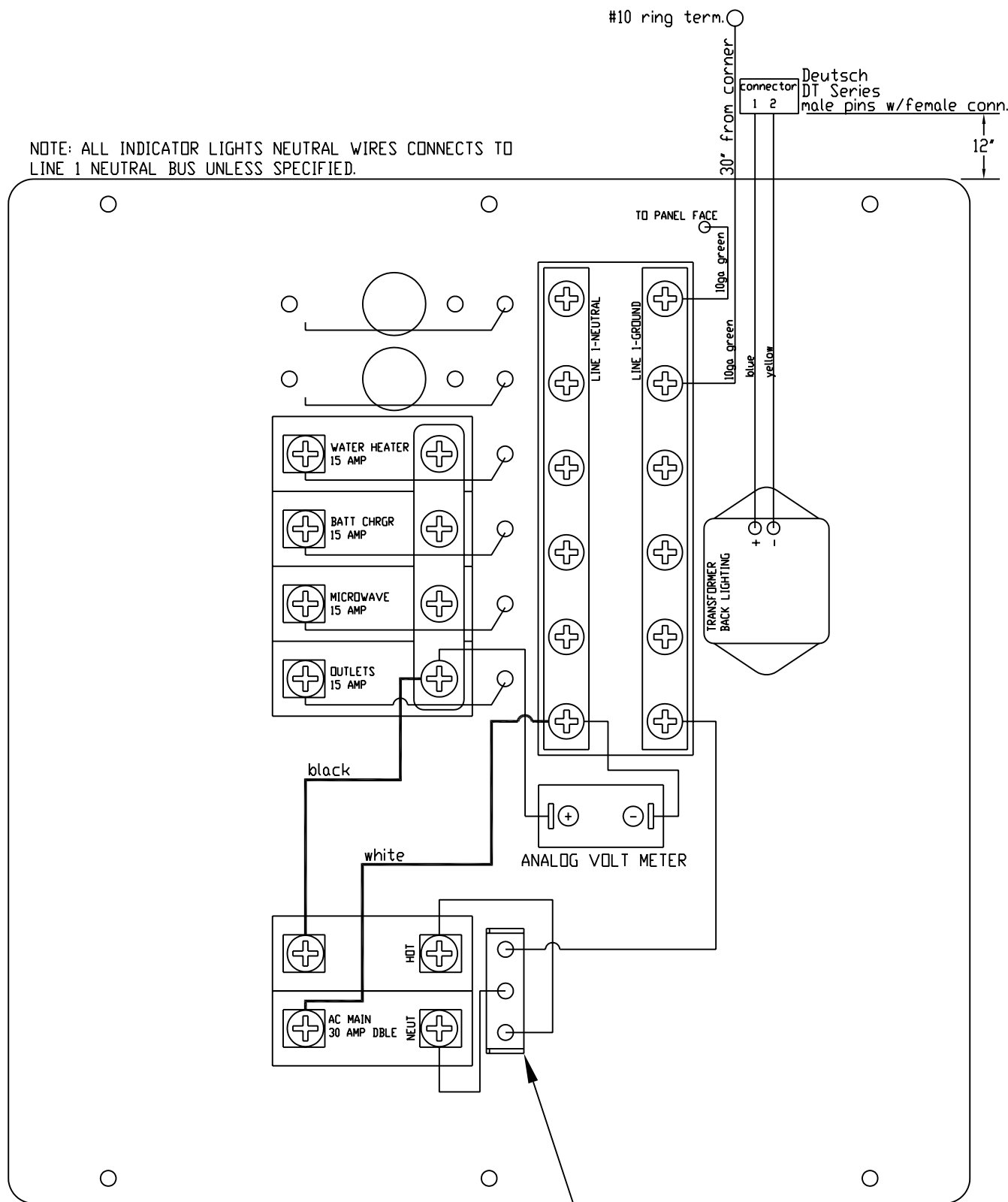

BREAKER LIST FOR 120V PANEL -

- AC MAIN - 30 AMP
- OUTLETS - 15 AMP
- MICROWAVE - 15 AMP
- BATTERY CHARGER - 15 AMP
- WATER HEATER - 15 AMP

BREAKER LIST FOR 230V PANEL -

- AC MAIN - 15 AMP
- OUTLETS - 10 AMP
- MICROWAVE - 10 AMP
- BATTERY CHARGER - 10 AMP
- WATER HEATER - 10 AMP

NOTE:

1. THIS SCHEMATIC MAYBE USED WITH DWG #00051002A AND #00051004A.
2. WIRES MUST BE UNIFORM AND TIE-WRAPED AS NEEDED.
3. SOME COMPONENTS SHOWN MAY NOT BE EXACT.
4. ALL DIMINSIONS IF ANY ARE IN INCHES.

SoLiCo 3450-1-20-1934A, for 120V panel
 SoLiCo 3452-1-20-1934A, for 230V panel

PROPRIETARY INFORMATION: THIS DRAWING CONTAINS INFORMATION FOR WHICH HUNTER MARINE CORPORATION HAS PROPRIETARY RIGHTS.



HUNTER GEN

DRAWING TITLE:

STD AC PANEL SCHEMATIC

DRAWN BY:	JLK	DATE:	17-Dec-03	SHEET	1	OF	1
SCALE:	0.625	HUNTER PART NO.	TBD	REVISION	-	DRAW #	00051002A-SCH

CHECKED:

CONN. T	TANK MONITOR ADAPTER	MATCHES	CONN. TYPE
1	pink, FUEL SENSOR (S)	#41, 16ga pink, FUEL SENSOR (S)	Deutsch - DT Series - 6 pin male connector w/female pins
2	orange/white, FUEL SENSOR (+)	#43, 16ga orange/white, FUEL SENSOR (+)	
3	orange/green, WASTE SENSOR (+)	#14, 16ga orange/green, WASTE SENSOR (+)	
4	pink/gray, WASTE SENSOR (S)	#15, 16ga pink/gray, WASTE SENSOR (S)	
5	orange/blue, WATER SENSOR (+)	#17, 16ga orange/blue, WATER SENSOR (+)	
6	pink/black, WATER SENSOR (s)	#18, 16ga pink/black, WATER SENSOR (s)	
CONN. G			
1	red/blue, TANK MONITOR (+)	#53, 16ga red/orange, TANK MONITOR (+)	DT Series - 2 pin female connector w/male pins
2	yellow or black, TANK MONITOR (-)	#54, 16ga yellow, TANK MONITOR (-)	

CONN. S	STEREO ADAPTER	MATCHES	CONN. TYPE
1	RED, STEREO PWR	#50, 16ga red, STEREO PWR	Deutsch-DT 3 pin female connector w/male pins
2	YELLOW, STEREO MEMORY	#51, 16ga yellow/red, STEREO MEMORY	
3	BLACK, STEREO (-)	#52, 16ga yellow, STEREO (-)	
CONN. SS			
1	WHITE	#9, 16ga white/orange, PORT MAIN SPEAKER (+)	Deutsch - DT Series - 8 pin male connector w/female pins
2	WHITE/BLACK	#10, 16ga white/yellow, PORT MAIN SPEAKER (-)	
3	GREEN	#21, 16ga white/pink, PORT ARCH SPEAKER (+)	
4	GREEN/BLACK	#22, 16ga white/yellow, PORT ARCH SPEAKER (-)	
5	PURPLE	#23, 16ga white/gray, STBD ARCH SPEAKER (+)	
6	PURPLE/BLACK	#24, 16ga white/black, STBD ARCH SPEAKER (-)	
7	GRAY	#30, 16ga white/blue, STBD MAIN SPEAKER (+)	
8	GRAY/BLACK	#31, 16ga white/black, STBD MAIN SPEAKER (-)	

CONN. Arch	ARCH HARNESS	MATCHES	CONN. TYPE
1	16ga blue/white, ARCH LIGHT	#19, 16ga blue/white, ARCH LIGHT	Deutsch - DT Series - 6 pin male connector w/female pins
2	16ga yellow, ARCH LIGHT (-)	#20, 16ga yellow, ARCH LIGHT (-)	
3	16ga white/pink, PORT ARCH SPEAKER (+)	#21, 16ga white/pink, PORT ARCH SPEAKER (+)	
4	16ga white/yellow, PORT ARCH SPEAKER (-)	#22, 16ga white/yellow, PORT ARCH SPEAKER (-)	
5	16ga white/gray, STBD ARCH SPEAKER (+)	#23, 16ga white/gray, STBD ARCH SPEAKER (+)	
6	16ga white/black, STBD ARCH SPEAKER (-)	#24, 16ga white/black, STBD ARCH SPEAKER (-)	

NOTE:

1. PANEL MATERIAL - 1/8" ALUMINUM
2. PANEL COLOR & FINISH - FLAT CARBON BLACK WITH GLOSSY BLACK BORDER
3. BACK LIGHTING COLOR - BLUE
4. AC MAIN INDICATOR - GREEN USING NEON BULB
REVERSE POLARITY INDICATOR - RED USING NEON BULB
BREAKER INDICATOR LIGHTS - RED LED
5. BREAKER HANDLE COLOR - BLACK
6. ADD HINGE TO BOTTOM OF PANEL.
7. SEE ELECTRICAL SCHEMATIC FOR BACKSIDE

BREAKER LIST TO BE SUPPLIED WITH PANEL FOR 120V-60 HERTZ VERSION.

- AC MAIN :30 AMP, DOUBLE
- GENERATOR :50 AMP, DOUBLE
- PARALLEL :30 AMP, DOUBLE
- OUTLETS :15 AMP
- MICROWAVE :15 AMP
- BATTERY CHARGER :15 AMP
- WATER HEATER :15 AMP
- AIR CONDITIONER :25 AMP
- SPARE :NONE

BREAKER LIST TO BE SUPPLIED WITH PANEL FOR 230V-50 HERTZ VERSION.

- AC MAIN :15 AMP, DOUBLE
- GENERATOR :30 AMP, DOUBLE
- PARALLEL :15 AMP, DOUBLE
- OUTLETS :10 AMP
- MICROWAVE :10 AMP
- BATTERY CHARGER :10 AMP
- WATER HEATER :10 AMP
- AIR CONDITIONER :15 AMP
- SPARE :NONE

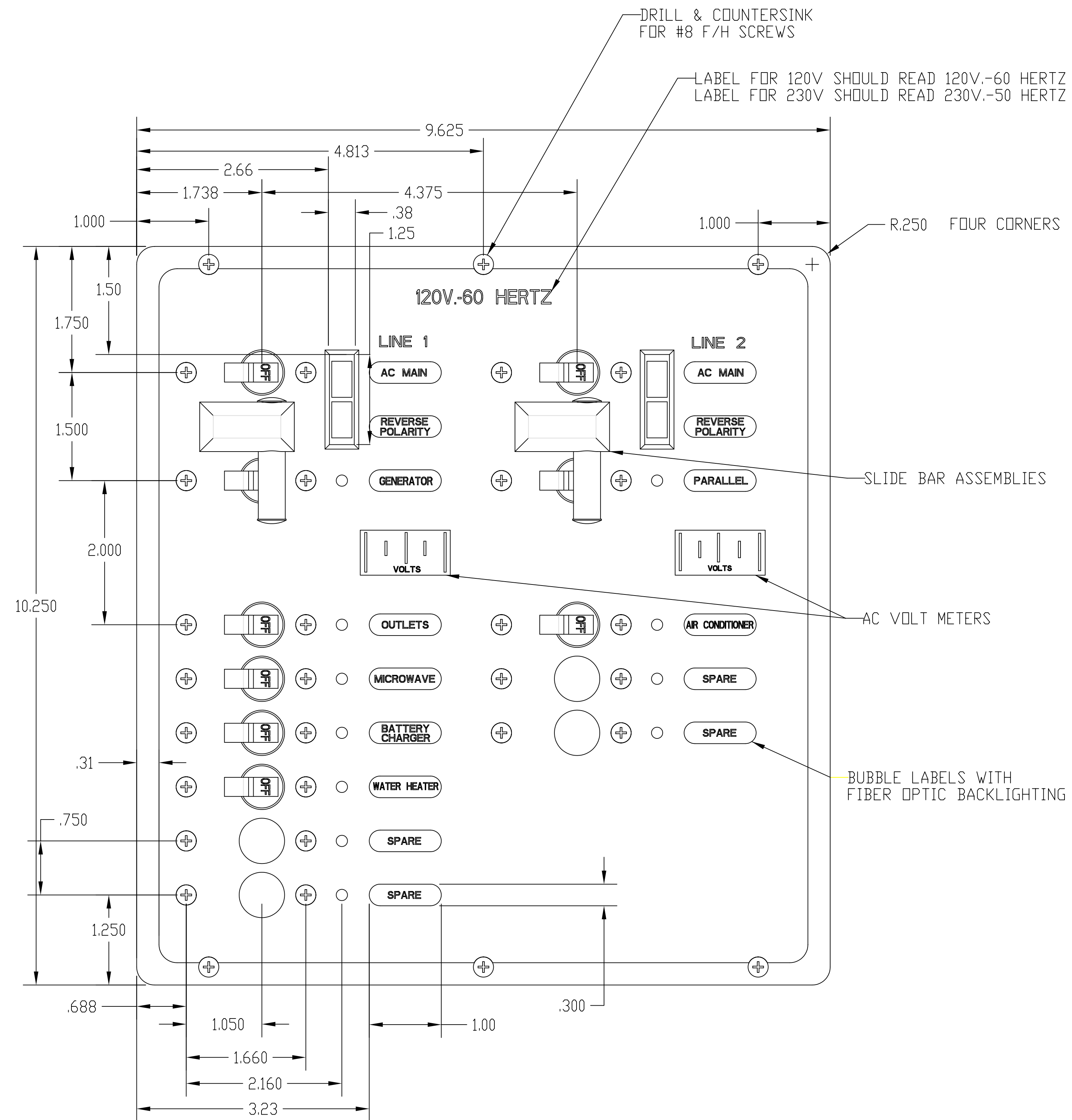

PROPRIETARY INFORMATION: THIS DRAWING CONTAINS INFORMATION FOR WHICH HUNTER WAGNER CORPORATION HAS PROPRIETARY RIGHTS.

HUNTER WAGNER GEN

DRAWING TITLE: 120/230VAC PANEL WITH AIR AND GENSET 2004 MODEL YEAR FOR H36			
DRAWN BY: JLK	DATE: 17-Apr-2003	SHEET 1 OF 1	
SCALE: 1.000	HUNTER PART NO. TBD	REVISION: -	DRAW # 00051003A

LEGEND
 — = 8ga wire
 — = 18-14ga wire
 10ga marked as shown.

NOTE: ALL INDICATOR LIGHTS NEUTRAL WIRES CONNECTS TO EITHER LINE 1 OR LINE 2 NEUTRAL BUS UNLESS SPECIFIED.

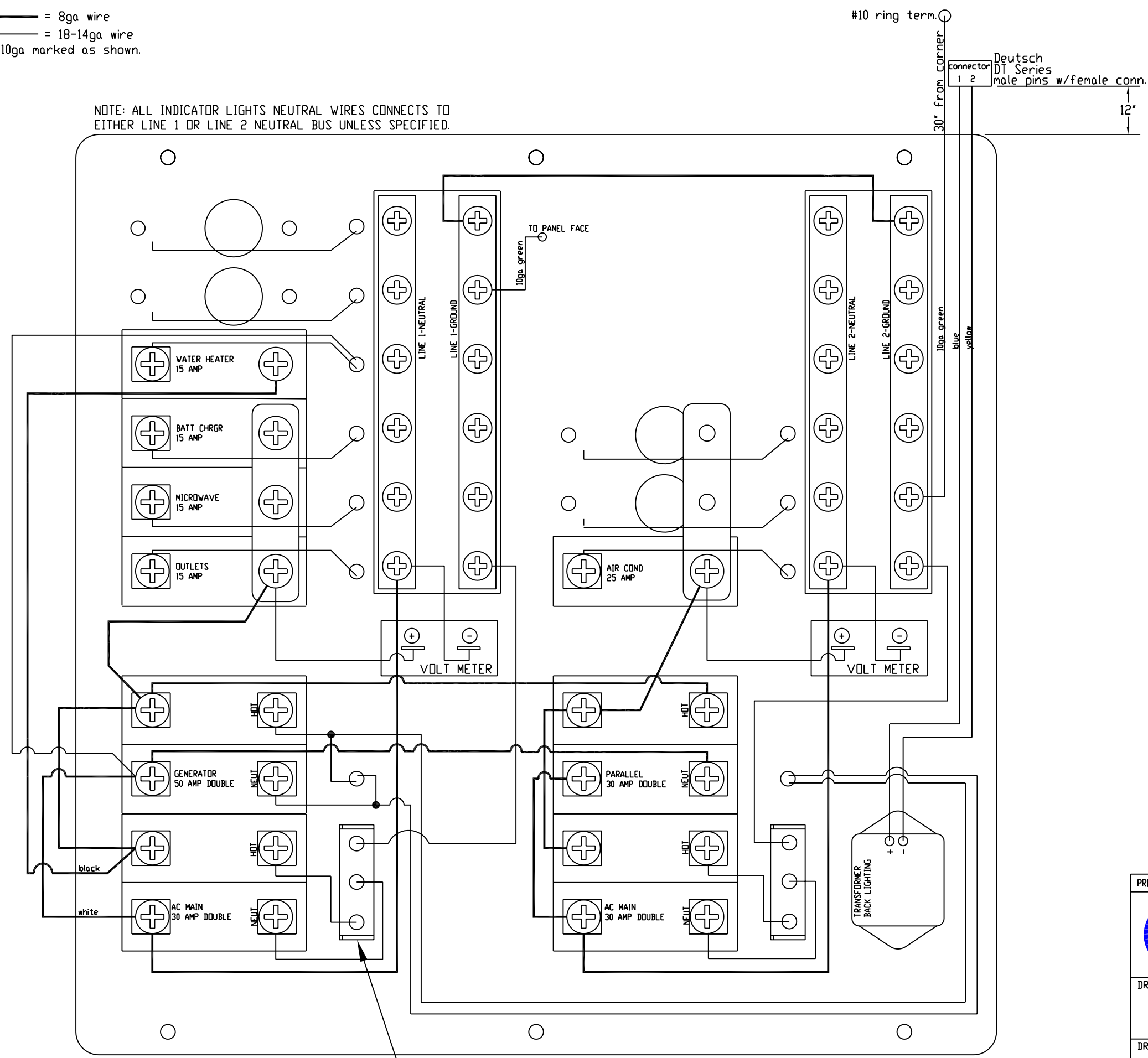

BREAKER LIST FOR 120V PANEL -

- AC MAIN - 30 AMP
- GENERATOR - 50 AMP
- OUTLETS - 15 AMP
- MICROWAVE - 15 AMP
- BATTERY CHARGER - 15 AMP
- WATER HEATER - 15 AMP
- FWD AIR COND. - 25 AMP
- AFT AIR COND. - 20 AMP
- AIR COND. RELAY - 5 AMP

BREAKER LIST FOR 230V PANEL -

- AC MAIN - 15 AMP
- GENERATOR - 30 AMP
- OUTLETS - 10 AMP
- MICROWAVE - 10 AMP
- BATTERY CHARGER - 10 AMP
- WATER HEATER - 10 AMP
- FWD AIR COND. - 15 AMP
- AFT AIR COND. - 10 AMP
- AIR COND. RELAY - 5 AMP

- NOTE:
1. WIRES MUST BE UNIFORM AND TIE-WRAPPED AS NEEDED.
 2. SOME COMPONENTS SHOWN MAY NOT BE EXACT.
 3. ALL DIMINSIONS IF ANY ARE IN INCHES.

SoLiCo 3450-1-20-1934A, for 120V panel
 SoLiCo 3452-1-20-1934A, for 230V panel

PROPRIETARY INFORMATION: THIS DRAWING CONTAINS INFORMATION FOR WHICH HUNTER MARINE CORPORATION HAS PROPRIETARY RIGHTS.



HUNTER GEN

DRAWING TITLE:
DUAL LINE AC PANEL SCHEMATIC

DRAWN BY: JLK	DATE: 18-Dec-03	SHEET 1	OF 1
SCALE: 0.750	HUNTER PART NO. TBD	REVISION -	DRAW # 00051003A-SCH

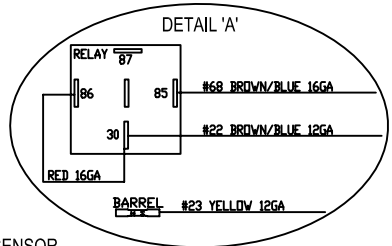
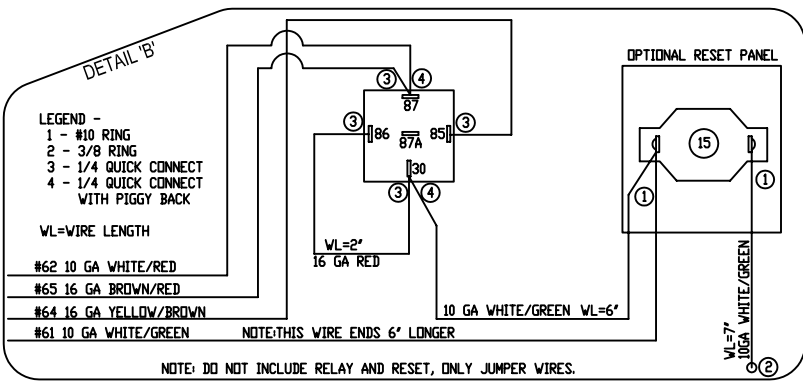
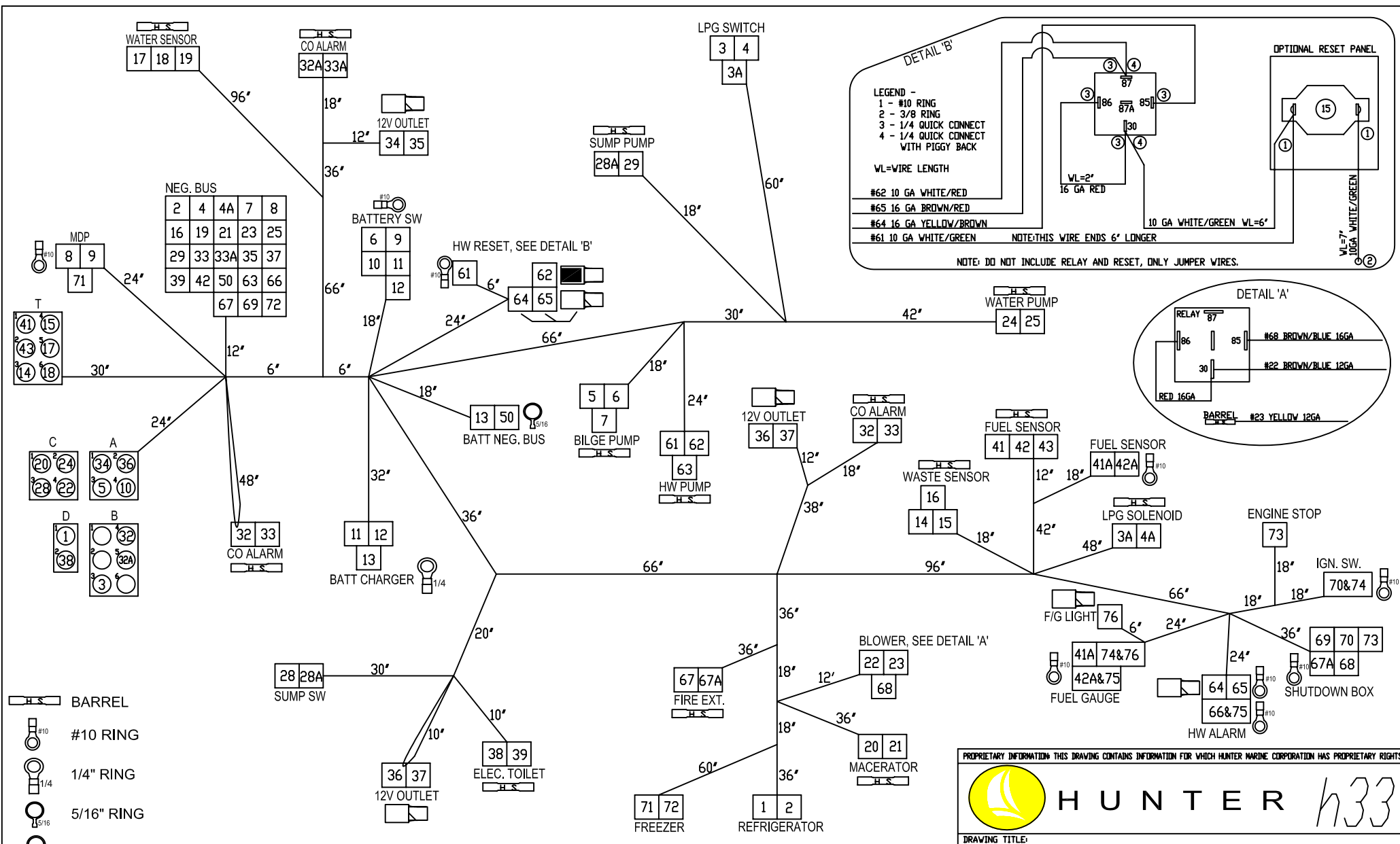

- BARREL
- #10 RING
- 1/4" RING
- 5/16" RING
- 3/8 RING
- 1/4 SLIDE
- 1/4 SLIDE WPIGGYBACK

E	ADD NEW FUEL GAUGE AND ENGINE STOP WIRE
D	ADJUSTED LENGTHS, SUMP PUMP, LPG AND WATER PUMP
C	MOVE BATT. NEG. BUS DROP (#13,50)
B	ADDED FREEZER
A	PRODUCTION RELEASE

PROPRIETARY INFORMATION THIS DRAWING CONTAINS INFORMATION FOR WHICH HUNTER MARINE CORPORATION HAS PROPRIETARY RIGHTS

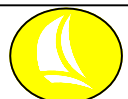

HUNTER *h33*

DRAWING TITLE: **HULL HARNESS**

DRAWN BY: *JLK* DATE: *29-Apr-04* SHEET *1* OF *1*

SCALE: *0.045* HUNTER PART NO. *TBD* REVISION *E* DRAW # *drawing number*

HULL HARNESS CONNECTORS for h33

All connectors to be male pins with female connectors.

REV. A
10/16/2003

CONN. A	WIRE# (HULL)	NOTES:	CONN. TYPE
1	#34, 14ga Red, 12V OUTLET		Deutsch - DTP Series - 4 pin
2	#36, 14ga Red, 12V OUTLET		
3	#5, 12ga Brown/Red, BILGE MANUAL		
4	#10, 12ga Tan, BILGE POWER		

CONN. B	WIRE# (HULL)		CONN. TYPE
1			Deutsch - DT Series - 6 pin
2			
3	#3, 16ga Orange/Red, LPG		
4	#32, 16ga Red/Blue, CO ALARM		
5	#32A, 16ga Red/Blue, CO ALARM		
6			

CONN. C	WIRE# (HULL)		CONN. TYPE
1	#20, 10ga Brown/White, MACERATOR		Deutsch - DTP Series - 4 pin
2	#24, 12ga Brown, WATER PUMP		
3	#28, 12ga Brown/Black, SUMP PUMP		
4	#22, 12ga Brown/Blue, BLOWER		







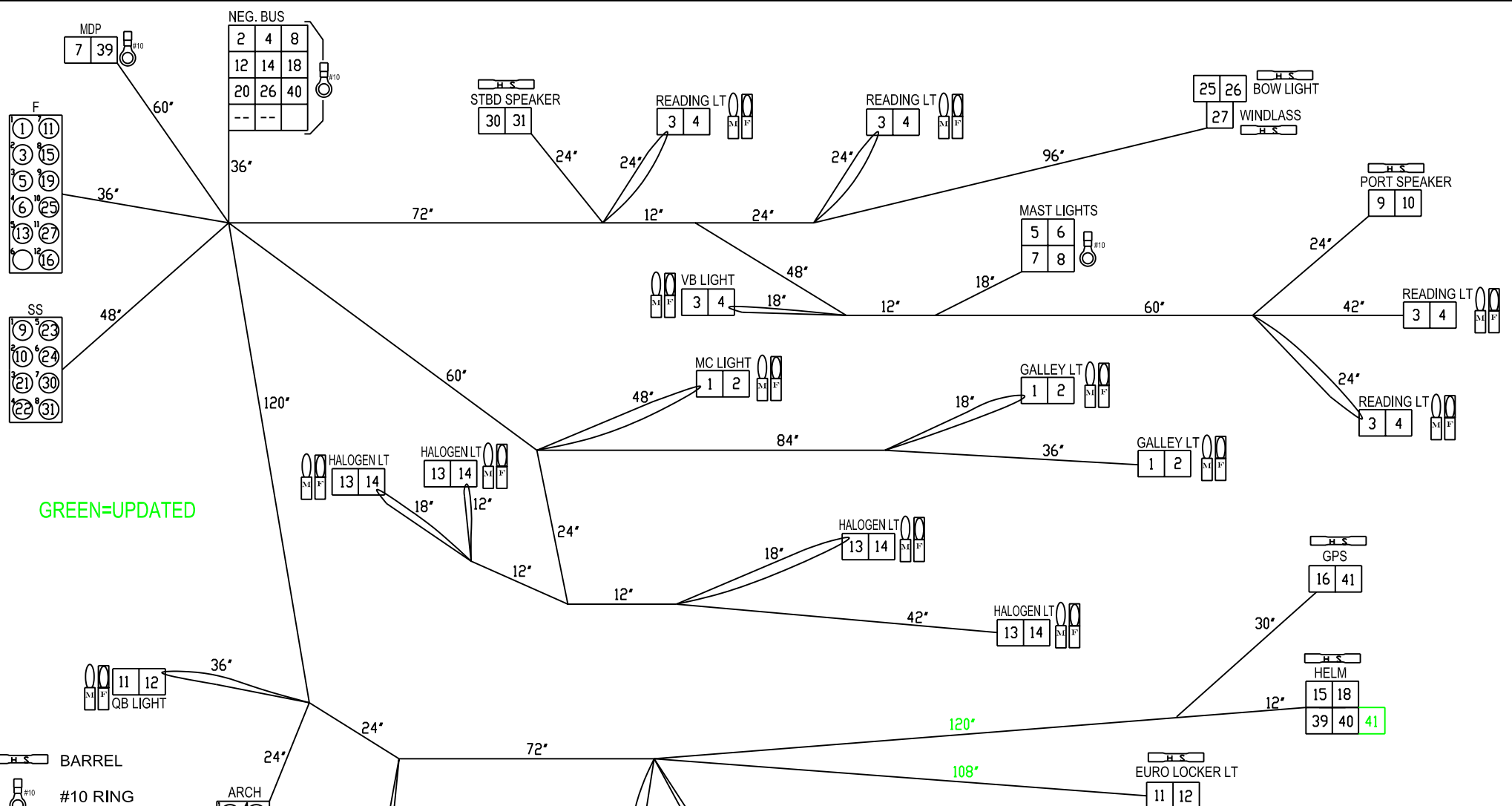

CONN. D	WIRE# (HULL)		CONN. TYPE
1	#1, 10ga Red/Black, REFRIGERATOR		Deutsch - DTP Series - 2 pin
2	#38, 10ga Brown/Pink, ELECTRIC TOILET		

CONN. T	WIRE# (HULL)		CONN. TYPE
1	#41, 16ga Pink, FUEL SENSOR (S)		Deutsch - DT Series - 6 pin
2	#43, 16ga Orange/White, FUEL SENSOR (+)		
3	#14, 16ga Orange/Green, WASTE SENSOR (+)		
4	#15, 16ga Pink/Gray, WASTE SENSOR (S)		
5	#17, 16ga Orange/Blue, WATER SENSOR (+)		
6	#18, 16ga Pink/Black, WATER SENSOR (s)		

HUNTER 33 DC HULL HARNESS			REV.E	4/29/2004
WIRE#	GAUGE	COLOR	LENGTH	FUNCTION
1	10	RED/BLACK	246"	REFRIGERATION
2	10	YELLOW	234"	REFRIGERATION NEG.
3	16	ORANGE/RED	192"	LPG PANEL SW
4	16	YELLOW	180"	LPG INDICATOR NEG.
3A	16	ORANGE/GREEN	402"	LPG SOLENOID (+)
4A	16	YELLOW	270"	LPG SOLENOID (-)
5	12	BROWN/RED	120"	BILGE MANUAL SW
6	12	BROWN/ORANGE	102"	BILGE AUTO
7	12	YELLOW	108"	BILGE NEG.
8	6	YELLOW	36"	DC MDP NEG.
9	6	ORANGE/RED	54"	DC MDP POWER
10	12	TAN	54"	BILGE POWER
11	8	ORANGE/GREEN	50"	BATTERY CHARGER
12	8	ORANGE/RED	50"	BATTERY CHARGER
13	8	YELLOW	50"	BATTERY CHARGER NEG
14	16	ORANGE/GREEN	252"	WASTE SENSOR (+)
15	16	PINK/BLUE	252"	WASTE SENSOR (S)
16	16	YELLOW	234"	WASTE SENSOR (-)
17	16	ORANGE/BLUE	198"	WATER SENSOR (+)
18	16	PINK/BLACK	198"	WATER SENSOR (S)
19	16	YELLOW	180"	WATER SENSOR (-)
20	10	BROWN/WHITE	210"	MACERATOR
21	10	YELLOW	198"	MACERATOR NEG.
22	12	BROWN/BLUE	204"	BLOWER
23	12	YELLOW	192"	BLOWER NEG.
24	12	BROWN	174"	WATER PUMP
25	12	YELLOW	162"	WATER PUMP NEG.
28	12	BROWN/BLACK	122"	SUMP PUMP SW
28A	12	BROWN/BLACK	200"	SUMP PUMP
29	12	YELLOW	138"	SUMP PUMP NEG.
32	16	RED/BLUE	290"	CO DETECTOR
33	16	YELLOW	278"	CO DETECTOR NEG.
32A	16	RED/BLUE	150"	CO DETECTOR
33A	16	YELLOW	138"	CO DETECTOR NEG.
34	12	RED	144"	12V OUTLET
35	12	YELLOW	132"	12V OUTLET NEG.
36	12	RED	248"	12V OUTLET
37	12	YELLOW	236"	12V OUTLET NEG.
38	10	BROWN/PINK	102"	ELECT. TOILET
39	10	YELLOW	90"	ELECT. TOILET NEG.
41	16	PINK	276"	FUEL SENSOR (S)
41A	16	PINK	150"	FUEL SENSOR (S)
42	16	YELLOW	258"	FUEL SENSOR (-)
42A	16	YELLOW	150"	FUEL SENSOR (-)
43	16	ORANGE/WHITE	276"	FUEL SENSOR (+)
44	16	BLUE	0	GALLEY LIGHT SWITCH
44A	16	BLUE	0	GALLEY LIGHT CIRCUIT
46	16	BLUE	0	M-C LIGHT SWITCH
46A	16	BLUE	0	M-C LIGHT CIRCUIT
50	6	YELLOW	42"	NEG BUS JUMPER
61	10	WHITE/GREEN	120"	HW PUMP AUTO
62	10	WHITE/RED	114"	HW PUMP MANUAL
63	10	YELLOW	114"	HW PUMP NEG
64	16	YELLOW/BROWN	312"	HW RELAY SW
65	16	BROWN/RED	312"	HW ALARM IND
66	16	YELLOW	312"	HW ALARM NEG
67	16	BLACK/YELLOW	198"	FIRE EXT.
67A	16	BLACK/YELLOW	258"	FIRE EXT. - SHUTDOWN
68	16	BROWN/BLUE	252"	BLOWER RELAY
69	16	YELLOW	312"	FIRE EXT. - SHUTDOWN BOX
70	16	RED	72"	IGNITION SWITCH
71	10	RED/WHITE	270"	FREEZER
72	10	YELLOW	258"	FREEZER NEG
73	16	WHITE/BROWN	72"	ENGINE STOP
74	16	RED	60"	FUEL GAUGE POWER
75	16	YELLOW	48"	FUEL GAUGE NEGATIVE
76	16	RED	6"	FUEL GAUGE LIGHT



GREEN=UPDATED

-  BARREL
-  #10 RING
-  1/4" RING
-  5/16" RING
-  3/8 RING
-  LIGHT CONNECTORS
-  blue wires bullet recept.
-  yellow wires bullet plug

C	UPDATE WIRE LENGTHS
B	DELETE LIGHT DROP

PROPRIETARY INFORMATION: THIS DRAWING CONTAINS INFORMATION FOR WHICH HUNTER MARINE CORPORATION HAS PROPRIETARY RIGHTS.

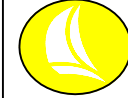

HUNTER *h33*

DRAWING TITLE: <i>DECK HARNESS</i>			
DRAWN BY: <i>JLK</i>	DATE: <i>16-Dec-03</i>	SHEET <i>1</i>	OF <i>1</i>
SCALE: <i>0.045</i>	HUNTER PART NO. <i>TBD</i>	REVISION <i>C</i>	DRAW # <i>drawing number</i>

CHECKED

DECK HARNESS CONNECTORS for h33

All connectors to be male pins with female connectors.

11/20/2003

CONN. F	WIRE# (DECK)	NOTES:	CONN. TYPE
1	#1, 16ga blue, CABIN LIGHTS		Deutsch - DT Series - 12 pin
2	#3, 16ga blue, CABIN LIGHTS		
3	#5, 14ga gray/red, ANCHOR LIGHT		
4	#6, 14ga gray/green, STEAMING LIGHT		
5	#13, 16ga blue, CABIN LIGHTS		
6			
7	#11, 16ga blue, STBD LIGHTS		
8	#15, 16ga gray/yellow, STERN LIGHT		
9	#19, 16ga blue/white, ARCH LIGHT		
10	#25, 16ga gray/white, BOW LIGHT		
11	#27, 16ga tan, WINDLASS		
12	#16, 16ga red/black, GPS		

CONN. SS	WIRE# (TO STEREO)		CONN. TYPE
1	#9, 16ga white/orange, PORT MAIN SPEAKER (+)		Deutsch - DT Series - 8 pin
2	#10, 16ga white/yellow, PORT MAIN SPEAKER (-)		
3	#21, 16ga white/pink, PORT ARCH SPEAKER (+)		
4	#22, 16ga white/yellow, PORT ARCH SPEAKER (-)		
5	#23, 16ga white/gray, STBD ARCH SPEAKER (+)		
6	#24, 16ga white/black, STBD ARCH SPEAKER (-)		
7	#30, 16ga white/blue, STBD MAIN SPEAKER (+)		
8	#31, 16ga white/black, STBD MAIN SPEAKER (-)		

CONN. Arch	WIRE# (TO ARCH)		CONN. TYPE
1	#19, 16ga blue/white, ARCH LIGHT		Deutsch - DT Series - 6 pin
2	#20, 16ga yellow, ARCH LIGHT (-)		
3	#21, 16ga white/pink, PORT ARCH SPEAKER (+)		
4	#22, 16ga white/yellow, PORT ARCH SPEAKER (-)		
5	#23, 16ga white/gray, STBD ARCH SPEAKER (+)		
6	#24, 16ga white/black, STBD ARCH SPEAKER (-)		

No Connector	WIRE# (to spare on panel)		
	#39, 10ga red, AUTOPILOT		
	#7, 16ga gray, DECK LIGHT		

HUNTER 33 DECK HARNESS			REV.-C	12/16/2003
WIRE#	GAUGE	COLOR	LENGTH	FUNCTION
1	16	BLUE	348"	CABIN LIGHTS
2	16	YELLOW	348"	CABIN LIGHTS NEG.
3	16	BLUE	510"	CABIN LIGHTS
4	16	YELLOW	510"	CABIN LIGHTS NEG.
5	14	GRAY/RED	198"	ANCHOR LIGHT
6	14	GRAY/GREEN	198"	STEAMING LIGHT
7	16	GRAY	222"	DECK LIGHT
8	10	YELLOW	198"	MAST LIGHTS NEG.
9	16	WHITE/ORANGE	276"	PORT MAIN SPEAKER
10	16	WHITE/YELLOW	276"	PORT MAIN SPEAKER NEG.
11	16	BLUE	654"	CABIN LIGHTS
12	16	YELLOW	654"	CABIN LIGHTS NEG.
13	16	BLUE	294"	CABIN LIGHTS
14	16	YELLOW	294"	CABIN LIGHTS NEG.
15	16	GRAY/YELLOW	432"	STERN LIGHT
16	16	RED/BLACK	402"	GPS
18	16	YELLOW	432"	STERN LIGHT NEG.
19	16	BLUE/WHITE	180"	ARCH LIGHT
20	16	YELLOW	180"	ARCH LIGHT NEG.
21	16	WHITE/PINK	192"	PORT ARCH SPEAKER
22	16	WHITE/YELLOW	192"	PORT ARCH SPEAKER NEG.
23	16	WHITE/GRAY	192"	STBD ARCH SPEAKER
24	16	WHITE/BLACK	192"	STBD ARCH SPEAKER NEG.
25	16	GRAY/WHITE	240"	BOW LIGHT
26	16	YELLOW	240"	BOW LIGHT NEG.
27	16	TAN	240"	WINDLASS
30	16	WHITE/BLUE	144"	STBD MAIN SPEAKER
31	16	WHITE/BLACK	144"	STBD MAIN SPEAKER NEG.
39	10	RED	408"	AUTO PILOT
40	10	YELLOW	408"	AUTO PILOT NEG.
41	16	YELLOW	42"	GPS NEG

33 AC WIRES

P/N 1002836

MODULE STAGE 24A

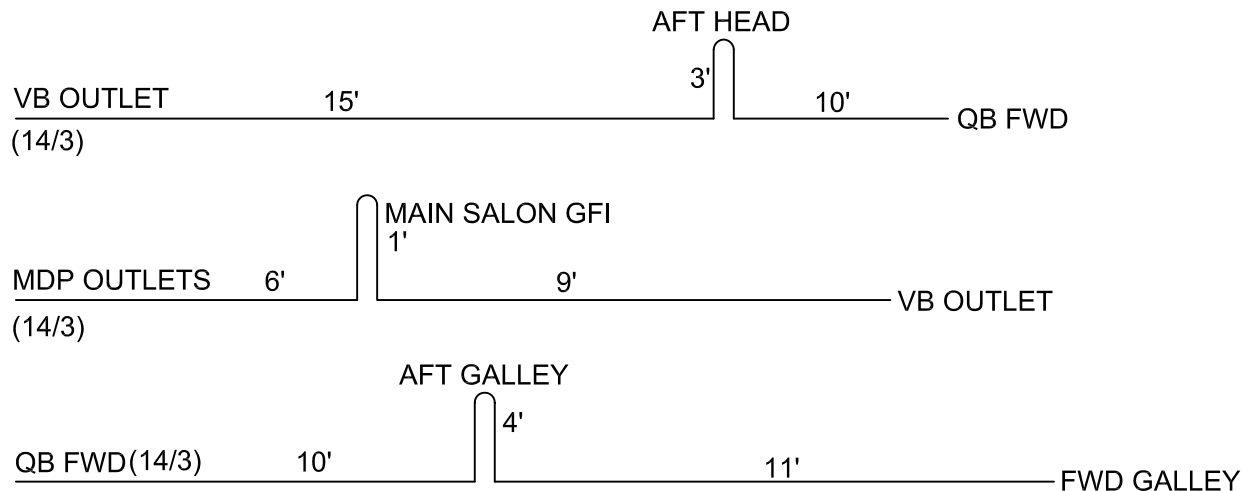

MICROWAVE (14/3) 24' MICROWAVE

RESET1 (10/3) 18' TRANS1 IN

RESET2 (10/3) 21' TRANS2 IN

SP1 (10/3) 5' RESET1

SP2 (10/3) 5' RESET2

TAPE THE FOLLOWING TOGETHER TO 14'

WATER HEATER (14/3) 18' WATER HEATER

MAIN1 (10/3) 18' TRANS1 OUT

MAIN2 (10/3) 21' TRANS2 OUT

AIR COND. (10/3) 30' AIR COND.

8' (14/3) A/C PUMP

4'
A/C PUMP

STAGE 24A-MODULE P/N 1002835						
	WIRE SIZE	COLOR	LENGTH	EYE	EYE	DESCRIPTION
HOUSE BATTERY #1	2/O	RED	5'	3/8"	3/8"	BATT TO SW-HOUSE1
	2/O	YELLOW	4'	5/16"	3/8"	BATT TO GND-HOUSE1
YANMAR STARTER	2 GA	RED	15' 6"	5/16"	3/8"	START TO STUD-YAN
	2 GA	YELLOW	13' 6"	3/8"	3/8"	ENGINE TO GND-YAN
GNDS	4 GA	GREEN/YELLOW	23'	1/4"	3/8"	ARCH GND
	4 GA	GREEN/YELLOW	10'	1/4"	3/4"	CHAINPLATE PORT
	4 GA	GREEN/YELLOW	10'	1/4"	3/4"	CHAINPLATE STBD
	10 GA	GREEN/YELLOW	25'			FUEL FILL GRD
	4 GA	GREEN/YELLOW	4' 2"	1/4"	3/8"	MAST POST TO KEEL
STAGE 56-ELECTRICAL P/N 1002838						
	WIRE SIZE	COLOR	LENGTH	EYE	EYE	DESCRIPTION
FIRE EXTIGUISHER	16 GA	WHITE/BROWN	4'			SHUTDOWN BYPASS
	16 GA	RED	4'			SHUTDOWN PWR
	16 GA	YELLOW	4'			SHUTDOWN NEGATIVE
BUSS BLOCKS	6 GA	YELLOW	8 INCHES	1/4"	1/4"	JUMPER GROUND
STAGE 34-DECK RIGGING P/N 1002837						
VHF RADIO	RG213	VHF COAX	18'			VHF COAX
GNDS	6 GA	GREEN/YELLOW	9'	3/8"	1/2"	PEDESTAL GND
OPTIONS						
MODULE STAGE 24 A						
	WIRE SIZE	COLOR	LENGTH	EYE	EYE	DESCRIPTION
HOUSE BATTERY #2	2/O	RED	6' 6"	3/8"	3/8"	BATT TO SW-HOUSE2
P/N 1002839	2/O	YELLOW	5' 6"	5/16"	3/8"	BATT TO GND-HOUSE2
BATT. CHAR. P/N 1002840	14-3	ROMEX	7'			BATT CHARGER
INVERTER (120V)	2/O	RED	1' 6"	3/8"	3/8"	INV TO FUSE
P/N 1002841	2/O	RED	2'	3/8"	3/8"	FUSE TO SW
	2/O	YELLOW	14 INCHES	5/16"	3/8"	INV TO GND
	1/0	GREEN/YELLOW	14 INCHES	5/16"	1/4"	INV CASE TO GND
	10-3	ROMEX	8'			INV IN
	10-3	ROMEX	8'			INV OUT
INVERTER (230V)	2/O	RED	2'	3/8"	3/8"	FUSE TO SW
P/N 1002842	1/0	GREEN/YELLOW	14 INCHES	5/16"	1/4"	INV CASE TO GND
	10-3	ROMEX	8'			INV IN
	10-3	ROMEX	8'			INV OUT
WINDLASS	2 GA	RED	20'	1/4"	5/16"	BREAKER TO BOX-WL
P/N 1002843	2 GA	YELLOW	22'	3/8"	5/16"	GND TO BOX-WL
	2 GA	RED	1' 6"	5/16"	5/16"	BOX TO MOTOR-WL
	2 GA	RED	1' 6"	5/16"	5/16"	BOX TO MOTOR-WL
	2 GA	RED	16"	3/8"	1/4"	WINDLASS JUMPER
	16 GA	YELLOW	1' 6"	5/16"	F-spade	CONTROL BOX NEG.
HALYARD	2 GA	RED	19'	1/4"	5/16"	BREAKER TO BOX-HAL
P/N 1002844	2 GA	YELLOW	18' 6"	3/8"	5/16"	GND TO BOX-HAL
	2 GA	RED	2'	1/4"	5/16"	BOX TO MOTOR-HAL
	2 GA	RED	2'	1/4"	5/16"	BOX TO MOTOR-HAL
	16 GA	BLUE	3'			HALYARD JUMPER
BILGE KEEL	12 GA	BROWN	12'			BILGE PUMP (+)

H33 02/11/2004

P/N 1006076

T V / D V D

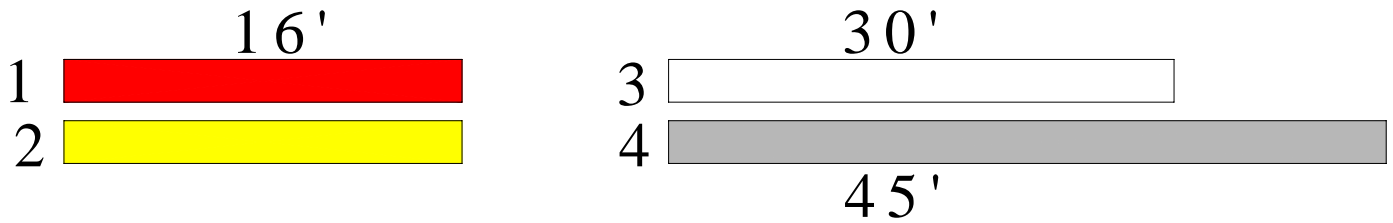

#	EYE	SIZE	EYE	COLOR	LENGTH	DESCRIPTION
1		10 GA		RED	16'	TV/DVD PWR
2		10 GA		YELLOW	16'	TV/DVD NEG.
3		RG59		COAX	30'	TV CABLE
4		22 GA		4 COND.	45'	PHONE CABLE

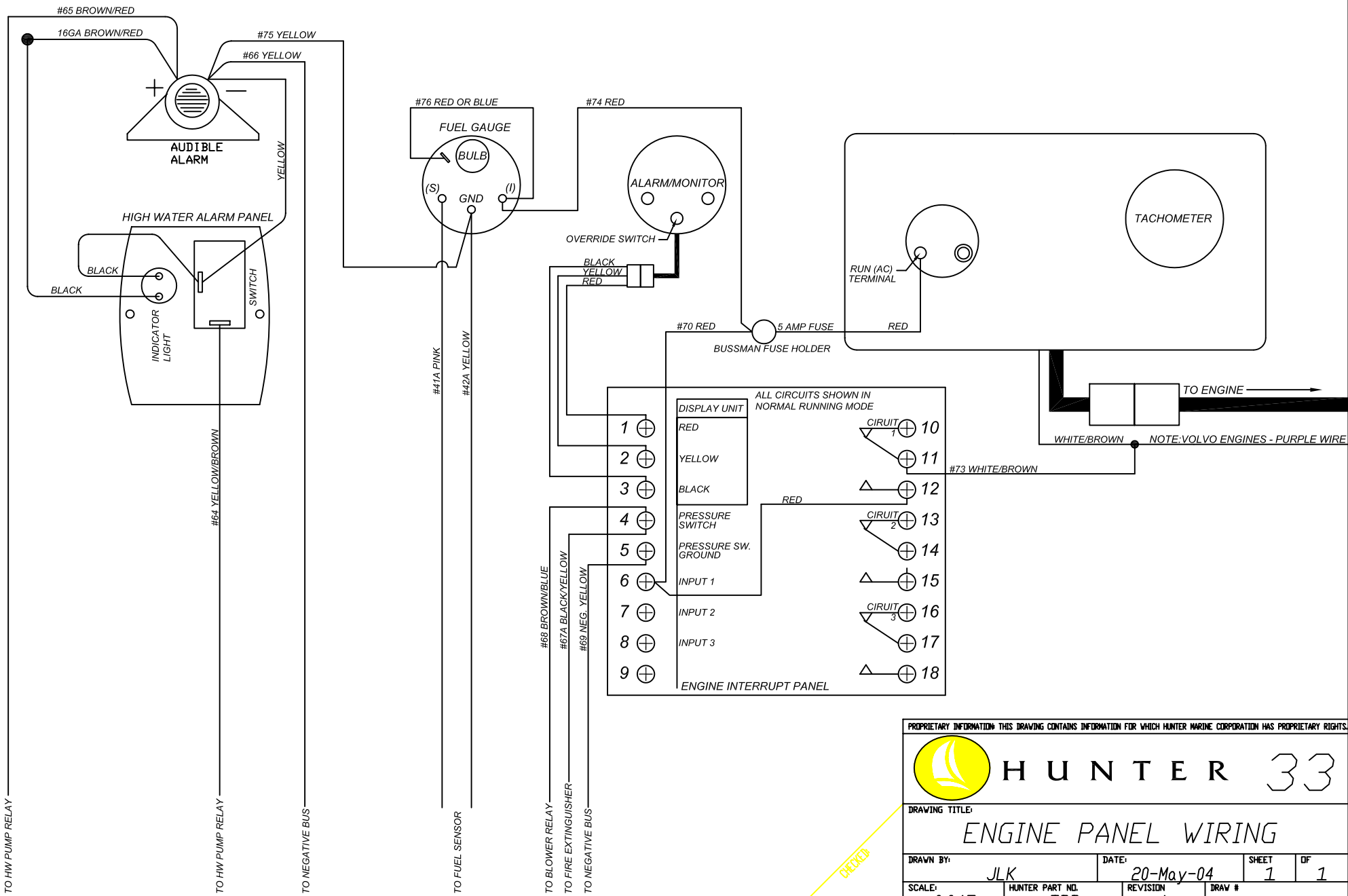

PROPRIETARY INFORMATION THIS DRAWING CONTAINS INFORMATION FOR WHICH HUNTER MARINE CORPORATION HAS PROPRIETARY RIGHTS.



HUNTER 33

DRAWING TITLE: ENGINE PANEL WIRING

DRAWN BY: JLK	DATE: 20-May-04	SHEET: 1	OF: 1
SCALE: 0.045	HUNTER PART NO. TBD	REVISION: A	DRAW #: -----

CHECKED

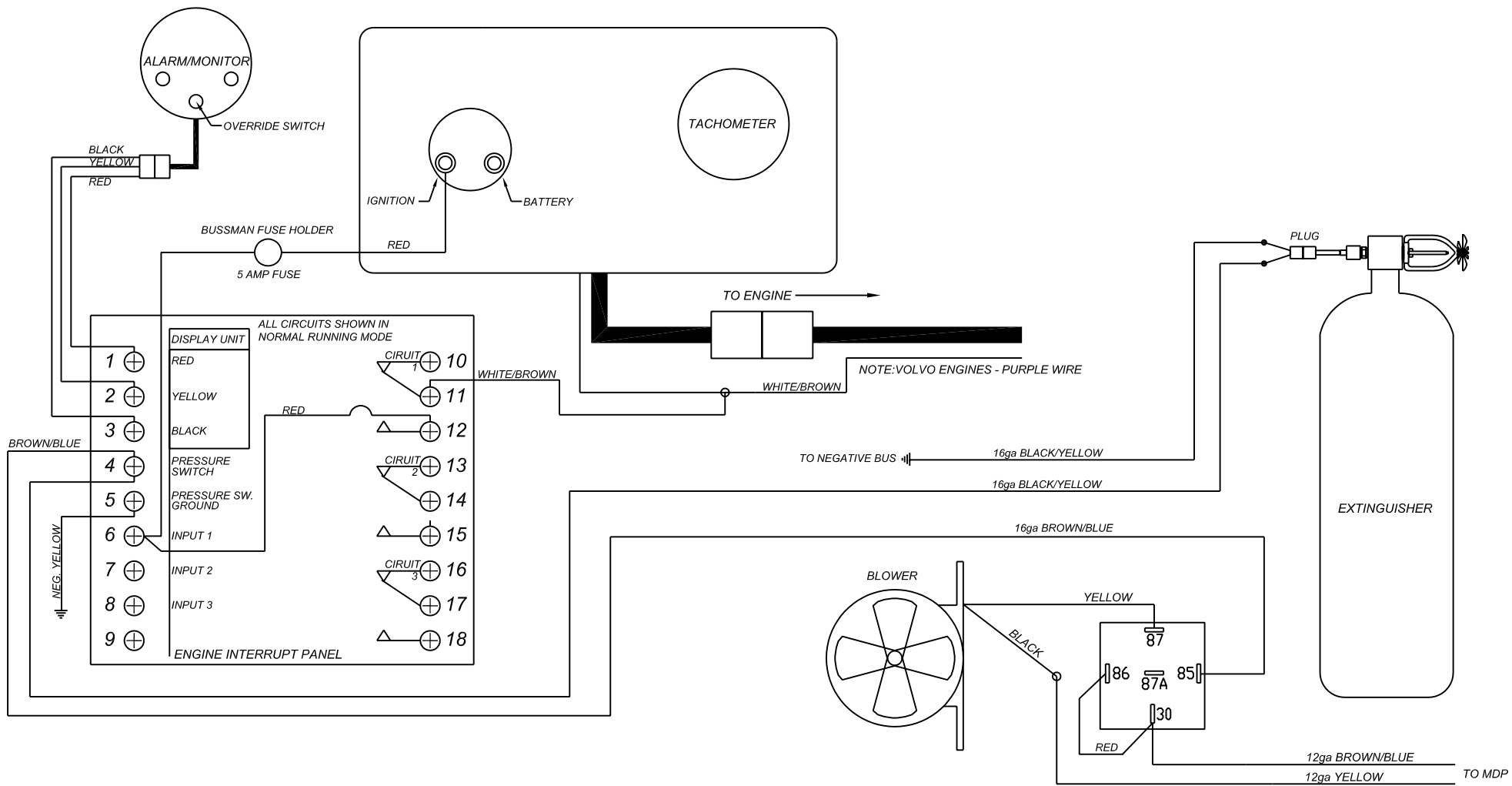

PROPRIETARY INFORMATION: THIS DRAWING CONTAINS INFORMATION FOR WHICH HUNTER MARINE CORPORATION HAS PROPRIETARY RIGHTS.

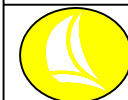

HUNTER 33

DRAWING TITLE: <i>AUTOMATIC FIRE EXTINGUISHER SCHEMATIC</i>				
DRAWN BY: JLK	DATE: 12-Aug-03	SHEET 1	OF 1	
SCALE: 0.045	HUNTER PART NO. TBD	REVISION A	DRAW # -----	

CHECKED

SYMBOL	REVISIONS	DATE	ENG
A	CHANGE TERMINALS ON AUDIBLE ALARM	7/21/2003	JLK

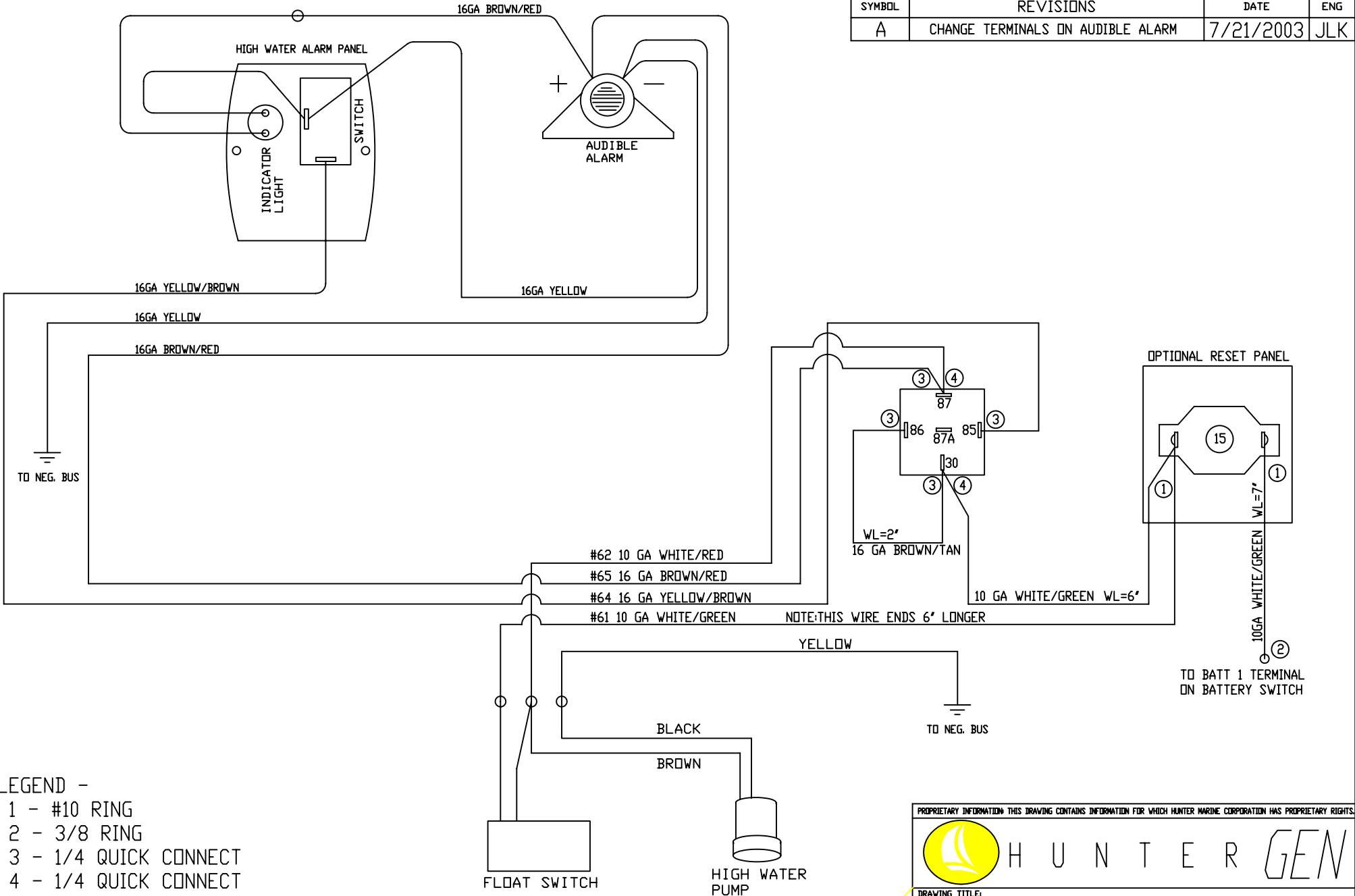

LEGEND -
 1 - #10 RING
 2 - 3/8 RING
 3 - 1/4 QUICK CONNECT
 4 - 1/4 QUICK CONNECT WITH PIGGY BACK

WL=WIRE LENGTH

PROPRIETARY INFORMATION THIS DRAWING CONTAINS INFORMATION FOR WHICH HUNTER MARINE CORPORATION HAS PROPRIETARY RIGHTS.



HUNTER GEN

DRAWING TITLE:
HIGH WATER BILGE PUMP SCHEMATIC 306/326

DRAWN BY: JLK	DATE: 2/27/2003	SHEET	OF
SCALE:	HUNTER PART NO.	REVISION	DRAW #

CHECKED

SYMBOL	REVISIONS	DATE	ENG

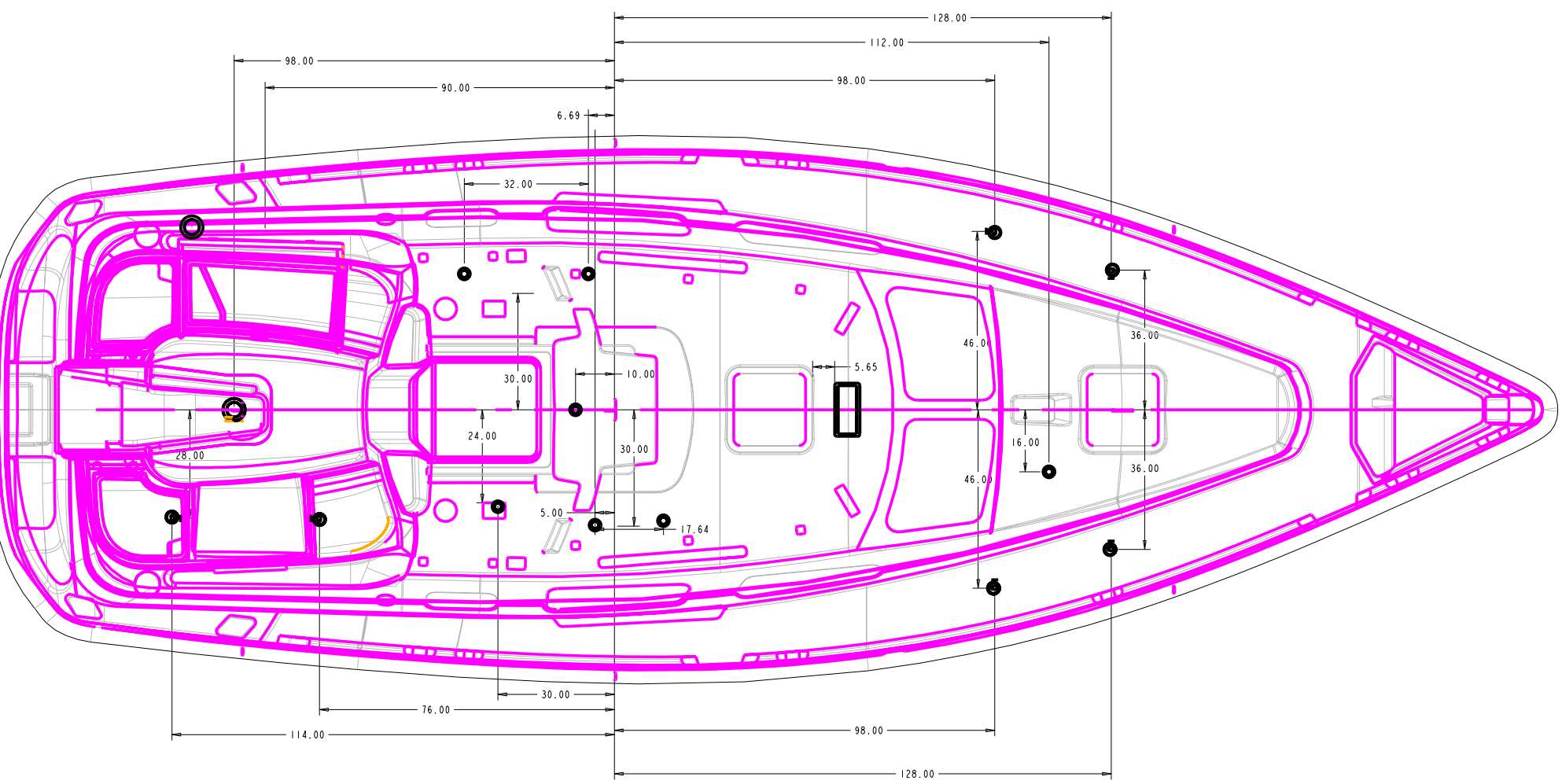

PROPERTY INFORMATION: THIS DRAWING CONTAINS INFORMATION FOR WHICH WATER WALKER CORPORATION HAS PROPRIETARY RIGHTS

THUNTER 332

DRAWING TITLE: **INTERIOR LIGHTING**

DRAWN BY: JM	DATE: 05/16/02	SHEET: 1	OF: 1
SCALE: 0/00	PAPER SIZE: 300	REVISED:	DRAWN:

332 LIGHTING