

# 356 SOP CHAFE GUARDS INSTALLATION

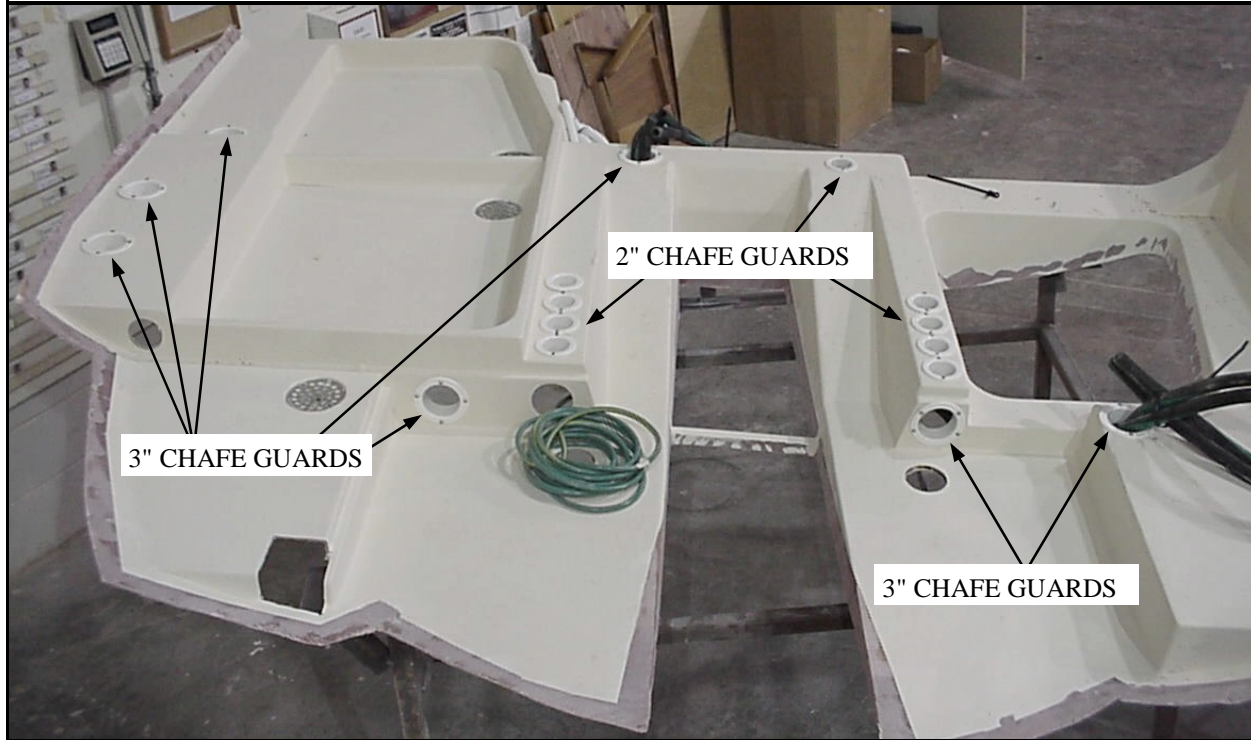

#	Qty.	Description	Size	Part #
1	7	Chafe Guard	3"	314440
2	9	Chafe Guard	2"	314430
3	46	Chafe Guard Fastener	#6 x 5/8" P/H	466870

1. There are two sizes of chafe guards used, 2" and 3". When securing the chafe guards to the pan always use two screws and locate them in the center of the ring on the forward and aft sides.
2. The nine 2" chafe guards will go in the nine 2" holes located (4) port, (4) starboard, and (1) starboard forward of the engine compartment.
3. One of the 3" chafe guards go in the 3" hole at the port forward end of the engine compartment three other 3" chafe guards go into the 3" holes in the pan near the head. Two of the last three 3" chafe guards goes into the port and starboard aft engine compartment and the last 3" chafe guard goes into the forward inboard corner of the heater compartment.
4. Place the chafe guards in position then drill thru the rings and pan with a 1/8" drill bit. The 2" guards get 2 fasteners each and the 3" guards get 4 fasteners each.
5. Secure the chafe guards to the pan using the designated fasteners.

Revision Dates:

Expected Time:

Page

# 356 SOP WATER STRAINER INSTALLATION

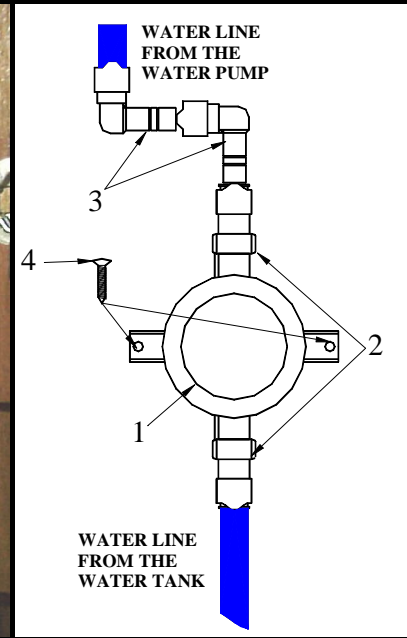

#	#Ea.	Description	Size	Part #
1	1	Water Strainer	36400-1010	352095
2	2	Adapter	1/2"F x 15mm	355237
3	2	Stem Elbow	15mm	355234
4	2	Water Strainer Fastener	#10 x 3/4" P/H	466670

Water Strainer

1. The water strainer will go in the aft-outboard-bottom corner of the cabinet under the galley sink.
2. Apply teflon tape to the male threads on the water strainer then attach the designated adapters to both sides of the water strainer.
3. On the output side of the strainer (there is a water directional arrow on the strainer) connect two stem elbows inline to the adaptor fitting (the drawing shows them for clarity, the picture shows the correct orientation).
4. Connect the water line coming from the fresh water tank to the inlet adapter then connect the stem elbow to the short piece of water line coming from the water pump.
5. The water strainer will not be able to move much because of the rigidity of the water line, mark where the strainer will be mounted on the wall then drill the mounting locations with a 1/8" drill bit and secure the strainer to the wall using the designated fasteners.

Revision Dates:

Expected Time:

Page

# 356 SOP WATER PUMP INSTALLATION

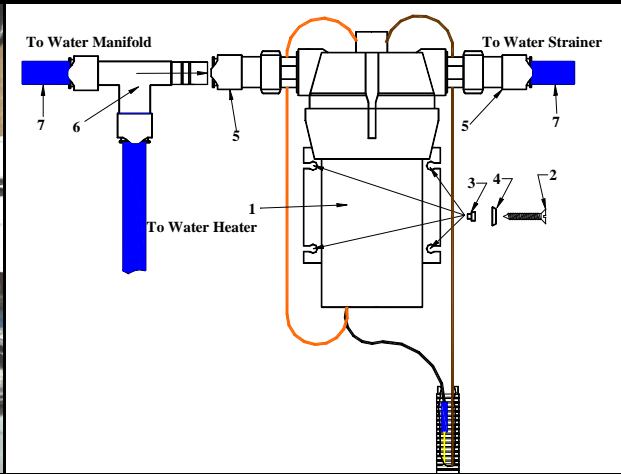

#	#Ea.	Description	Size	Part #	#	#Ea.	Description	Size	Part #
1	1	Water Pump	2.8 GPM	351951	5	2	Adapter	1/2" F-15 mm	355237
2	4	Water Pump Fasteners	#10 x 1/2" F/H	466590	6	1	Stem Tee	15 mm	355230
3	4	Grommet Washers	1/4"	469590	7	2	Cold Tubing	15 mm X 2-1/2"	359045
4	4	Finish Washers	#10	469170					

1. The water pump will be located on the outboard wall of the galley sink cabinet. Before mounting the pump the plumbing fittings will be connected to the pump then the pump will be plumbed to the water manifold so the exact mounting location can be determined.
2. Apply teflon tape to the male threads on the water pump then screw the designated adapters into the pump. Attach a stem tee to the outlet side adapter (the pump has a directional arrow on outlet side). Attach a 2-1/2" piece of tubing to the inlet adapter and a 2-1/2" to the stem tee (the side directly across from the stem portion).
3. Attach the cold water tubing that goes to the water heater to the bottom of the tee then attach the short piece of tubing on the tee to the elbow from the manifold.
4. Mark the mounting hole locations then drill the marked locations using a 5/32" drill bit. NOTE: Do not drill all the way thru the cabinet.
5. Secure the water pump to the cabinet using the designated fasteners and washers.
6. Attach the ground wire (yellow) from the harness to the black wire from the water pump using a blue butt connector.
7. Attach the brown wire from the harness to the slip-on connector on top of water pump (this connector is provided with the water pump).

Revision Dates:

Expected Time:

Page

# 356 SOP WATER MANIFOLD INSTALLATION

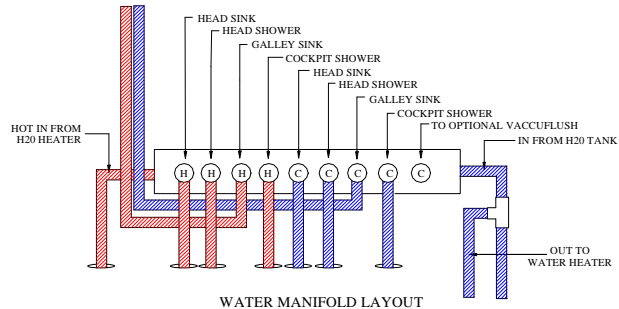
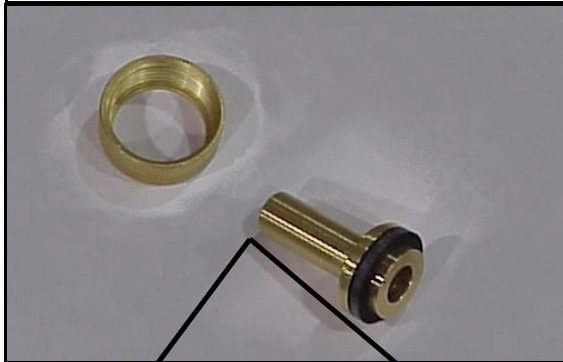

#	Qty.	Description	Size	Part #
1	1	Manifold Kit	NMK100	355240
2	2	Stem Elbows	15 mm	355234
3	4	Bracket Fasteners	#8 X5/8 P/H	466970
4	2	Equal Elbows	15 mm	355238
5	1	Identification Labels Set	N/A	



- The manifold kit will consist of the manifold, front cover, mounting brackets, brass stem assembly, and two equal elbows.
- The water manifold will be located on the forward wall of the galley sink cabinet underneath the shelf. Measure 2" down from the shelf and 4" in from the cabinet wall then put the top outside corner of the mounting brackets at these locations. Mark the mounting hole locations then drill the marked locations with a 1/8" drill bit making sure not to drill all the way thru the cabinet. Secure the brackets to the cabinet using the designated fasteners.
- The manifold will need to be prepared by first taking the shutoff key that is attached to the manifold and turning each of the valves open then shut. The valves tend to get stuck if the part has been sitting in a warehouse for a while. Some caution is needed when doing this as some of the valves stems have broken off instead of the valve breaking free. Take out the red plugs out of the water valves that will be used.
- Next take the two 3-part brass assemblies (two brass pieces, one washer) and attach them to both ends of the manifold. The black washer will go over the short stem on the assembly then that will go into the end of the manifold (so the long stem is sticking out). Take the other brass piece and slip it over the long stem then screw it onto the manifold tightly.
- Place an equal elbow on each of the long brass stems. NOTE: These elbows must be the ones that come in the kit manufactured by Sea-Tech, Whale fittings will slip off of the brass stems.
- Two stem elbows will need to be attached to the equal elbow on the cold water side of the manifold. These can be manufactured by Sea-Tech or Whale.
- Place the identification labels, in the order shown on the drawing, onto the cover plate. Snap the cover plate onto the manifold.
- Snap the manifold onto the brackets then cut the water lines to the correct length and attach them to their appropriate fitting. For the water lines that will run to the galley sink cut a piece of the hot & cold tubing so after attaching an equal elbow on one end and attaching the other end to the manifold the elbow will be about 1/2" above the bottom shelf. NOTE: All of the tubes will need to be pushed all the way into the fittings so they will not leak. It may be necessary to take the manifold back off of the brackets to accomplish this.

Revision Dates:

Expected Time:

Page

# 356 SOP SHOWER INSTALLATION

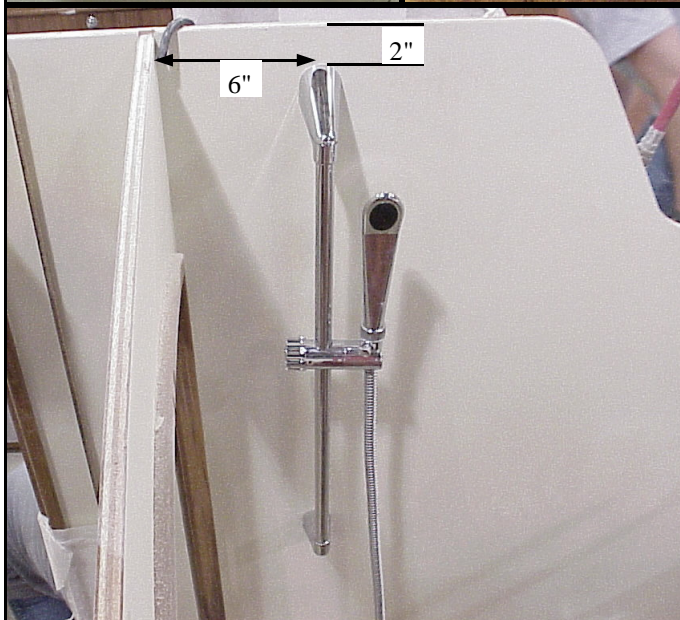
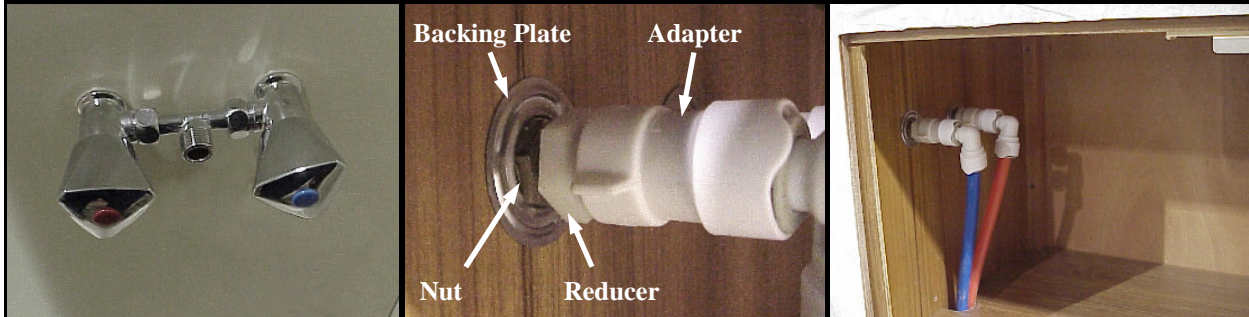

#	Qty.	Description	Size	Part #
1	1	Shower Combination	14118	351696
2	2	Adapter	1/2" F- 15mm	355237
3	2	Stem Elbow	15 mm	355234
4	2	Bracket Fasteners	#8 x 5/8 P/H	466970

1. From inside the shower stall place the shower faucet stems thru the two holes in the port companionway bulkhead so the hot water knob is on the left (forward) side. On the inboard side of the bulkhead place a backing plate and a nut over each of the faucet stems then tighten them well. Attach the reducers that comes with the shower kit to the faucet stems then connect the designated adapters to the reducers. Tighten all of these components well. Attach stem elbows to the adapters then cut the water lines to the correct length then attach them to the elbows (the hot water line goes on the forward fitting).
2. Back on the outboard side of the bulkhead (inside the shower stall) place the top mounting bracket for the sliding rail shower head holder so the center is 6" aft of the middle head bulkhead and the top is 2" below the top of the bulkhead. Mark the mounting hole location then drill the marked location with a 1/8" drill bit (make sure not to go all the way thru the bulkhead). Attach the bracket to the bulkhead using the designated fastener.
3. Slide the shower head holder onto the round bar then place one end of the bar into the top bracket. Make sure the bar is plumb then place the other bracket onto the bottom of the bar and mount the bracket to the bulkhead in the same manner as the top bracket. Snap the bracket covers onto the brackets.
4. Attach one end of the flexible hose to the faucet and the other end to the shower head. Place the shower head into the holder.

Revision Dates:

Expected Time:

Page

# 356 SOP RECEPTACLE INSTALLATION

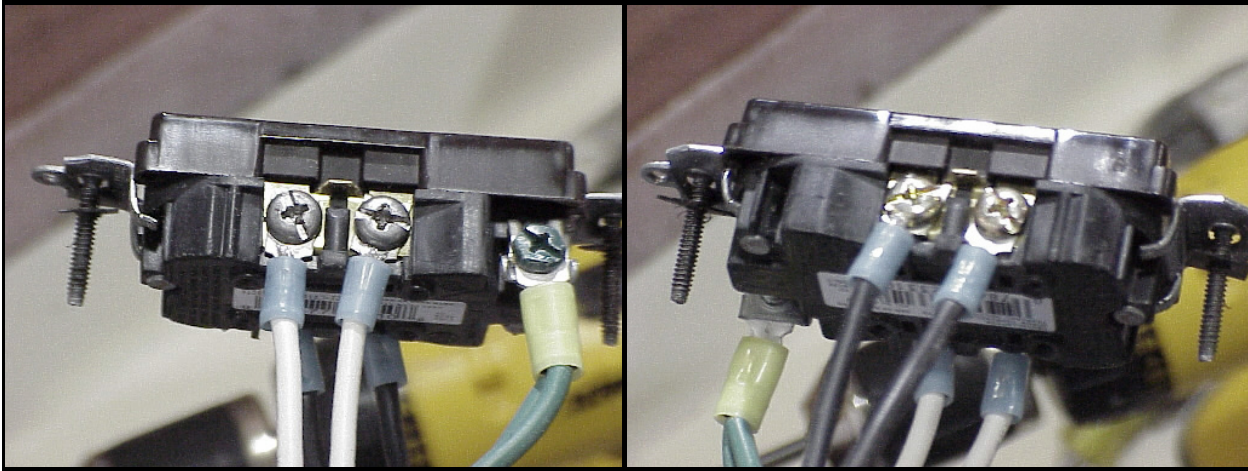

#	#Ea.	Description	Size	Part #
1	5	Receptacle	Brown	251165
2	1	Receptacle	White	251170
3	6	Outlet Box (Blue)	Plastic	251420
4	4	Receptacle Cover	Brown	250840
5	1	Wet Location Cover	White	251005
6	6	Blue Wire Terminals	N/A	257714
7	12	Yellow Wire Terminals	N/A	257732

1. There are two receptacle wiring styles, one for the “inline” receptacles and one for the “end of the line receptacles”. The end of the line receptacles will only have one romex wire, one is the microwave receptacle (in the upper galley cabinet) and the other is the receptacle on the starboard side of the aft kickboard. The inline receptacles will have two romex wires (one coming in and one going out) and are located in the V-berth port hanging locker hanging, upper galley cabinet, Q-berth hanging locker (it will be just aft of the aft galley bulkhead, the locker will not be mounted until the pre-deck stage), and the vanity. With the exception of the vanity all the receptacles are brown, the vanity is white. Also the vanity gets a white "wet location" cover. The microwave does not get a cover.
2. Pull the romex wires through the back of the outlet box then strip all of the wires 5/8” back. If the receptacle is inline secure the two power wires (black) together with a yellow wire terminal. Do the same with the ground wires (green) and the neutral wires (white). If the receptacle is at the end of line attach a blue wire terminal to the power wire, the ground wire, and the neutral wire.
3. Place the outlet box in position then secure by turning the screws that will open the tabs on the back of the box. (The microwave and Q-berth hanging locker boxes will not be mounted.)
4. Attach the ground wire(s) to the green colored screw.
5. Attach the neutral wire(s) to the middle connector on same side of receptacle as the ground screw. Note: The neutral and ground are always on the same side of receptacle (the side with three screws).
6. Attach the power wire(s) to the connector on the opposite side of the receptacle as the neutral wire.
7. Place the receptacle in the outlet box so the ground plug is on the bottom then secure using the designated fasteners.
8. Place the receptacle cover in position and secure using the fasteners that come with the cover.

# 356 SOP READING LIGHTS INSTALLATION

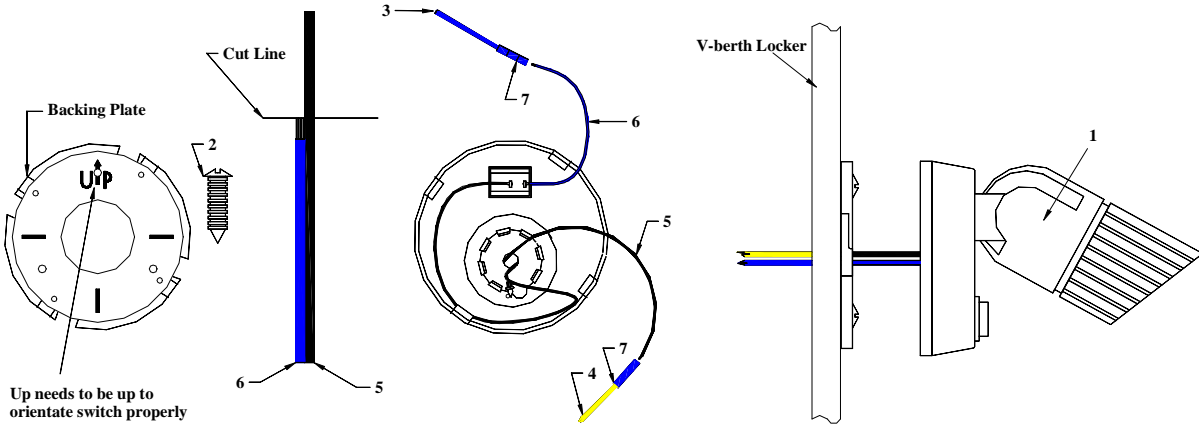

#	Qty.	Description	Size	Part #
1	2	Reading Light	Beige	255662
2	6	Reading Light Fasteners	#6 x 5/8" P/H	466870
3	2	Harness Wire (Blue)	16 Ga.	655100
4	2	Harness Wire (Yellow)	16 Ga.	659800
5	2	Reading Light Wire (Black)	N/A	N/A
6	2	Reading Light Wire (Blue)	N/A	N/A
7	4	Butt Connectors (Blue)	C1614-SC	257570

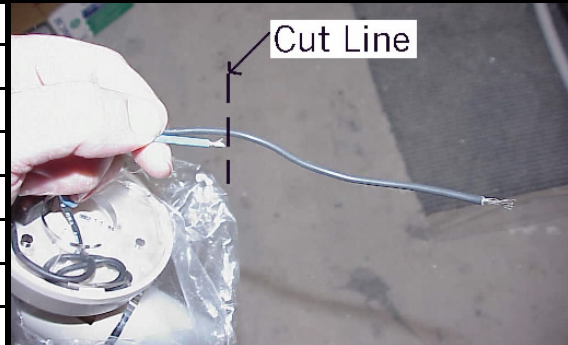

1. Cut the reading light black wire even with the blue wire.
2. Reading lights will be located on the forward face on both V-berth hanging lockers.
3. Place the backing plates in centered over the hole in the locker so the "up" on the backing plate is up (this is to orientate the switch down when installed).
4. Secure the backing plate to the furniture using the designated fasteners.
5. Pull the wires from the harness through the center hole.
6. Attach the reading light blue wire to the harness blue wire using a blue butt connector.
7. Attach the reading light black wire to the harness yellow wire using a blue butt connector.
8. Attach the reading light to the backing plate and twist to lock into place so the switch is down.

Revision Dates:

Expected Time:

Page

# 356 SOP PVC PLACEMENT INSTALLATION

Page 1 of 2

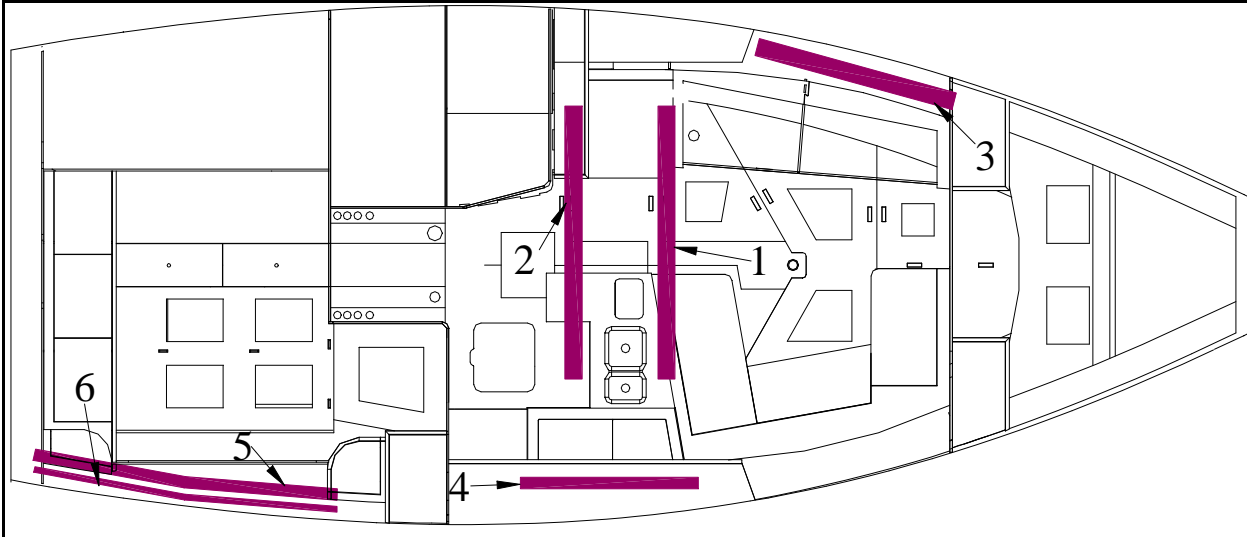

#	Qty.	Description	Size	Part #	#	Qty.	Description	Size	Part #
1	1	PVC Pipe	2" x ? (PR) 160	358737	5	1	PVC Pipe	1-1/2" X ? (Sch) 160	358683
2	1	PVC Pipe	2" x ? (PR) 160	358737	6	1	PVC Pipe	1" x 7' (PR 160 Thin Wall)	358647
3	1	PVC Pipe	2" x ? (PR) 160	358737	7	8	PVC Fasteners	#10 x 1" F/H	461050
4	1	PVC Pipe	1-1/2" X ? (Sch) 160	358683					

1. Two PVC pipes (#1 & #2 in the drawing) will need to be put in right after the sub floors are installed and before the furniture is installed. The other pipes will need to be put in after the furniture is installed as they go thru holes in the furniture.
2. One of the 2" pipes, #1, will need to have two holes cut into it to allow wires from the harness to drop out. The holes should be about 3" - 4" long. Cut the first hole \_\_\_\_" from the end and the other hole in the middle of the pipe. These holes should be cut on a bandsaw.
3. Place the #1 pipe under the sub floor and against the forward side of the mid beam. Hold the pipe up to the underside of the floor so the middle hole is facing forward and centered over the keel area. Drill thru the sub floor and the pipe with a C-7 drill assembly then secure the pipe to the floor using the designated fasteners. Secure the pipe to the sub floor in this fashion in six places that are somewhat evenly spaced.
4. Place the #2 pipe under the sub floor against the forward side of the aft beam then secure it to the underside of the sub floor in the same manner as the first pipe.
5. After the furniture has been installed (at least the piece the pipe will go thru) the other pipes can be installed.
6. Place the #3 pipe thru the holes in the supports of the port bunk locker and the V-berth port hanging locker. The forward end of the pipe should extend into the bottom of the hanging locker about 1" which will place the aft end about two-thirds thru the aft compartment of the bunk.
7. Place the #4 pipe under the galley ice box. The forward end will go thru a hole-notch in the galley and the aft end will need to be held up with a tie-wrap secured to the galley.
8. Pipes #5 & #6 will run side by side thru holes in the starboard side of the aft kickboard and the Q-berth bunk.

Revision Dates:

Expected Time:

Page



# 356 SOP PVC PLACEMENT INSTALLATION

Page 2 of 2

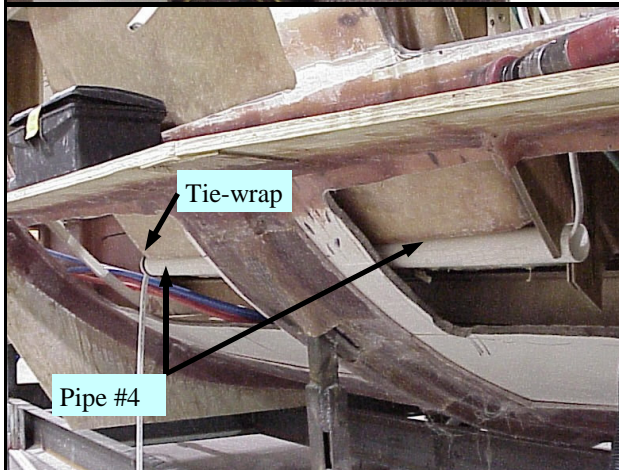
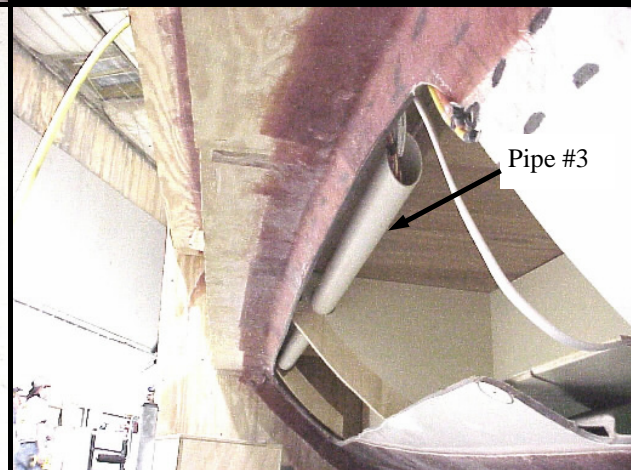
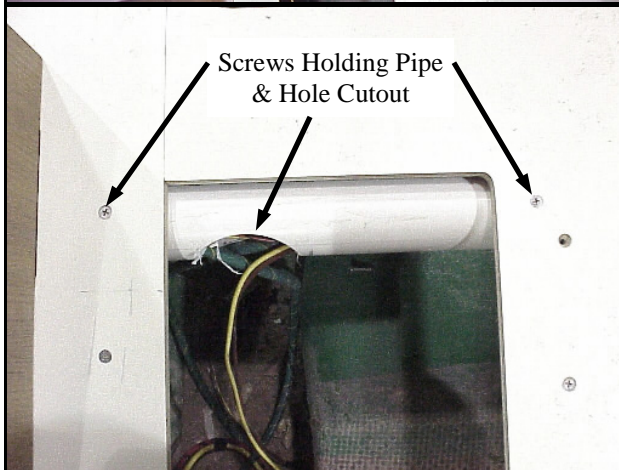
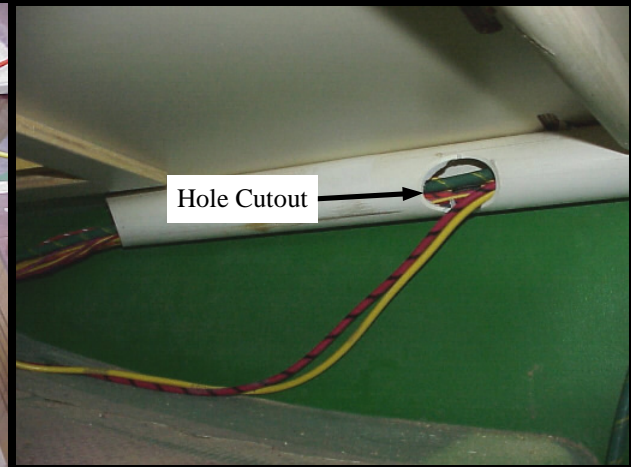
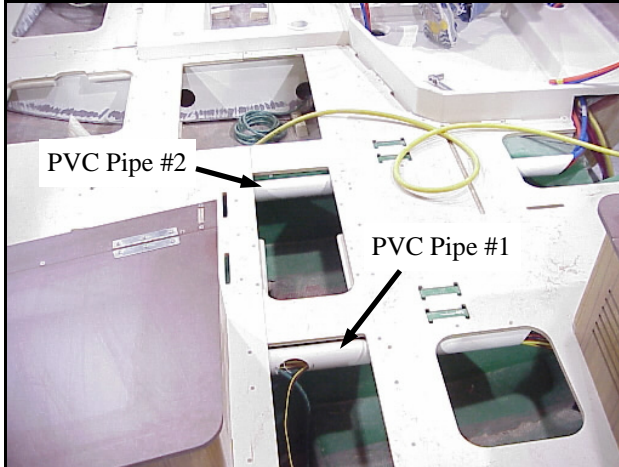

Revision Dates:

Expected Time:

Page

# 356 SOP PROPANE PANEL INSTALLATION

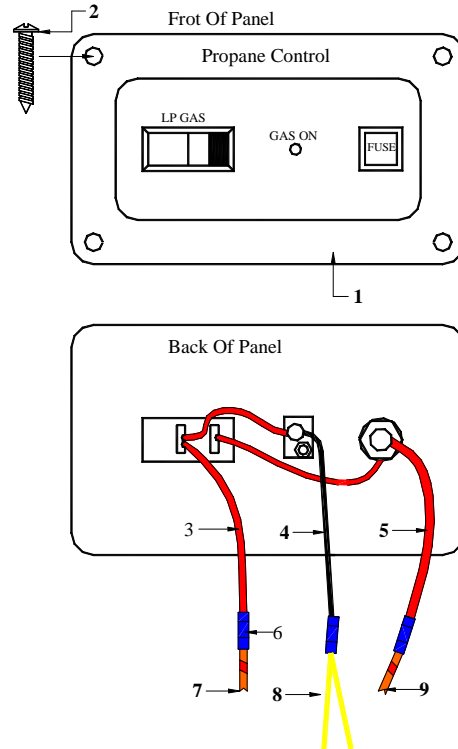
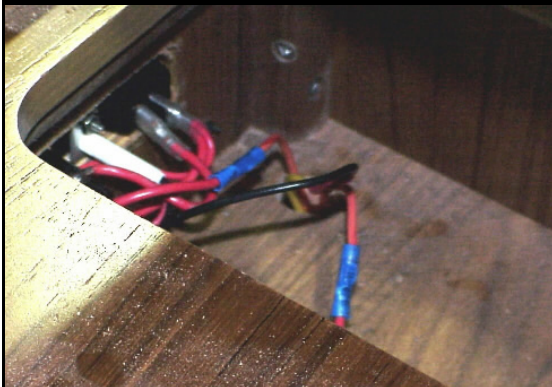
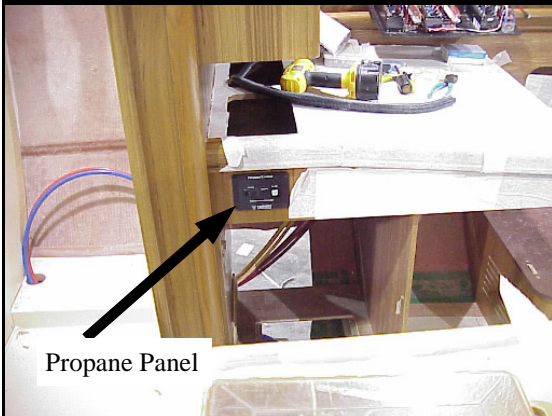

#	Qty.	Description	Size	Part #
1	1	Propane Control	N/A	316933
2	4	Propane Panel Fasteners	#8 x 5/8" T/H	466970
3	1	Panel Switch Wire (Red)	Comes with	Panel
4	1	Panel Wire (Black)	Comes with	Panel
5	1	Panel Fuse Wire (Red)	Comes with	Panel
6	1	Butt Connectors (Blue)	400 lb.	257570
7	1	Relay Wire (Orange/Red)	16 Ga.	659802
8	2	Ground Wire (Yellow in Harness)	16 Ga.	659800
9	1	Power Wire (Orange/Red)	16 Ga.	659802

1. Locate the cutout for the propane panel on the inboard chart locker face then place the propane panel in position (make sure panel is straight and centered) and secure it to the chart locker using the designated fasteners.
2. Attach one of the orange/red wires from the harness to one of the red wires on the panel, connect the other orange/red from the harness to the other red wire from the panel using the designated connectors.
3. Attach the black wire from the panel to the yellow wires from the harness using the designated connectors.
4. Secure the wires to the bottom of the chart locker using tie-wraps

Revision Dates:

Expected Time:

Page

# 356 SOP LPG HOSE RUN INSTALLATION



<ol style="list-style-type: none"> <li>1. Starting at the aft-starboard end of the boat run the LPG hose forward thru the 1-1/4" PVC pipe. When the hose comes out the forward end of the pipe continue forward then up into the area of the galley cabinet that the oven and/or stove will go.</li> <li>2. Loop up and secure both ends of the hose so it will not fall into the way when the module is placed into the hull.</li> </ol>	#	Qty.	Description	Size	Part #
	1	1	LPG Hose	5/16" X 20'	316930
<b>Revision Dates:</b>			<b>Expected Time:</b>		<b>Page</b>

## 356 SOP HEATER EXCHANGE HOSE RUN INSTALLATION

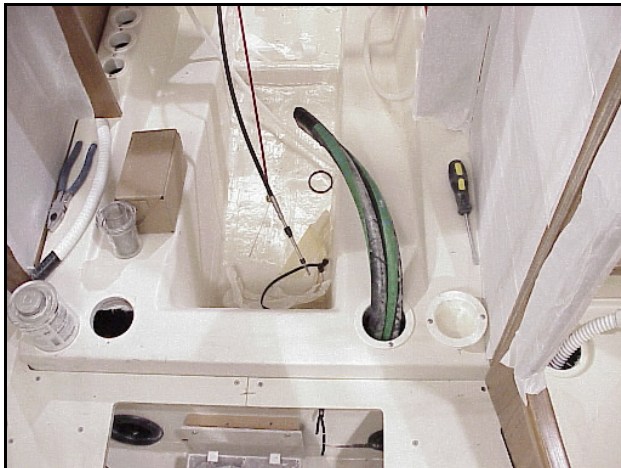

#	#Ea.	Description	Size	Part #
1	2	Heater Exchange Hose	5/8" X	
<ol style="list-style-type: none"> <li>1. The heater exchange hoses were attached to the back of the water heater during the installation of the water heater. Tape the loose ends of the hoses together.</li> <li>2. Run the two hoses along the inboard side of the water heater then thru the hole in the forward-inboard corner of the water heater compartment. Continue under the pan then come up out of the port-forward hole in the engine compartment.</li> <li>3. The hoses will be attached to the engine later.</li> </ol>				
Revision Dates:			Expected Time:	Page 18

# 356 SOP HEAD AND HEAD HOSES INSTALLATION

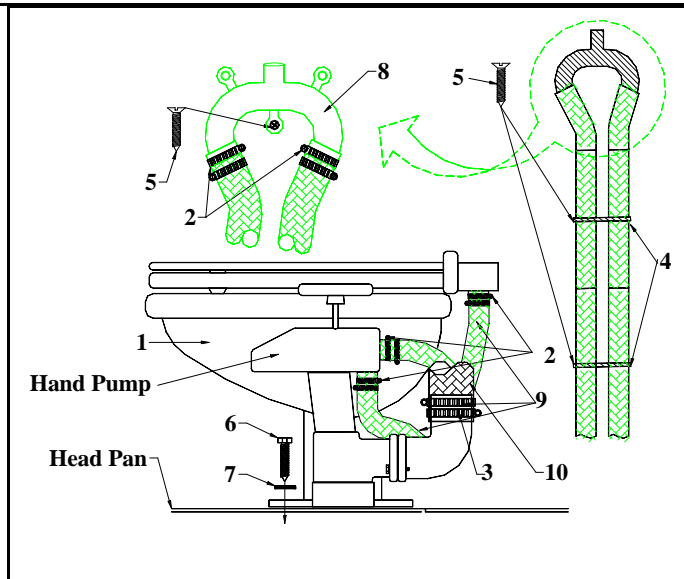

#	#Ea.	Description	Size	Part #	#	#Ea.	Description	Size	Part #
1	1	Head	Right Hand	350169	6	4	Head Fasteners	5/16" x 1 1/2" S/S Lag Bolt	464070
2	5	Hose Clamps	#10	353355	7	4	Neo Washers	5/16"	469630
3	2	Hose Clamps	#24	353427	8	1	Vented Loop	Black	355138
4	2	Tie-Wrap	15" with eye	460250	9	3	Head Hoses	3/4" x	358035
5	3	Vent Fasteners	#8 x 5/8" P/H	466970	10	1	Head To Waste Hose	1-1/2" X 16' "Low Perm" Sanitation Hose	358413

1. Use the fiberglass splash to mark the mounting hole locations for the head on the pan in the head area. (Fig. 1)
2. Drill the mounting hole locations with a 13/64" drill bit. (Fig. 2-3)
3. Apply super lube or vaseline to the two nipples on the hand pump, the nipple on the back of the head and on the ends of the three hoses that goes onto the nipples. (Fig. 4)
4. Attach the head hoses with the designated clamps to all three nipples (the two on the hand pump and the one on the back of the head). (Fig. 5)
5. Mark the other end of the bottom hose coming from the hand pump (this hose is directed to a separate hole). (Fig. 6)
6. Install the seat lid with the manufacturer's kit then replace the plastic and lid box on the lid to minimize potential damage to the lid. (Fig. 7)
7. Place the head in position on the pan lining the holes on the base of the pan with the holes drilled into the pan. Secure the head to the pan using the designated fasteners and washers (do not over-tighten). (Fig. 8-9)
8. Loosen the two nuts on the elbow at the bottom of the hand pump then turn the elbow so it faces slightly aft then retighten the nuts. (Fig. 10)
9. From underneath the pan run the "head to waste tank hose" thru the aft 3" hole (Fig. 11), apply pipe joint compound to the end of the elbow and the connecting end of the waste tank hose (Fig. 12-13). Attach the hose to the elbow at the bottom of the hand pump with the two designated clamps. (Fig. 14)
10. Run the two vent hoses (the top hose on the pump and the hose on the back of the head) down the middle 3" hole then run aft under the pan and out the 3" hole at the bottom of the aft head bulkhead into the wet locker. (Fig. 15-16)
11. Run the pick-up hose (the marked hose on the bottom of the hand pump) down the middle 3" hole inboard and forward of the other two hoses and thru the 3" hole in the pan on the port side of the sump pump compartment (just forward of the engine compartment. (Fig. 17)
12. Run the two vent hoses up the bulkhead wall, cut hoses off about 2" down from the top of the wet locker door. (Fig. 18)
13. Attach the ends of the vent hoses to the vented loop using the designated clamps (Fig. 19-20). Run the two vent hoses up the bulkhead in between the wet locker door opening and the shelves on the backside of the aft head bulkhead wall, then attach the vented loop to the bulkhead using the designated fasteners approximately 4" under the wet locker top. (Fig. 21)
14. Tie wrap the hoses together just below each shelf, secure them to the bulkhead with the designated fasteners. (Fig. 22)

Revision Dates:

Expected Time:

Page

# 356 SOP HEAD AND HEAD HOSES INSTALLATION

Fig 1



Fig 2

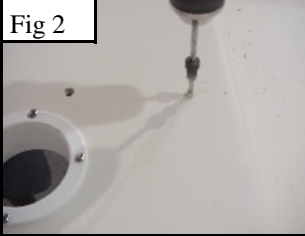

Fig 3



Fig 4

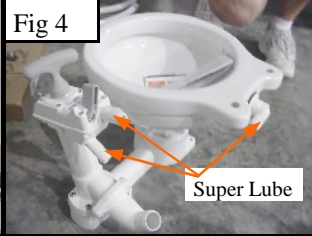

Fig 5



Fig 6

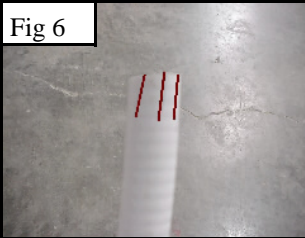

Fig 7

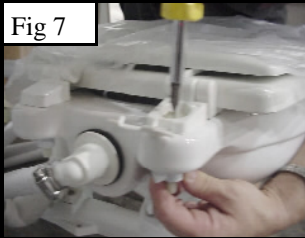

Fig 8

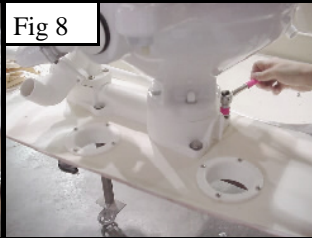

Fig 9

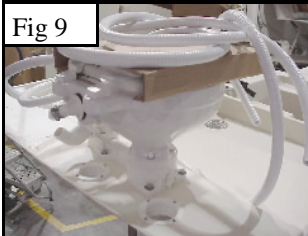

Fig 10

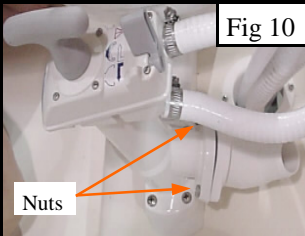

Fig 11



Fig 12



Fig 13

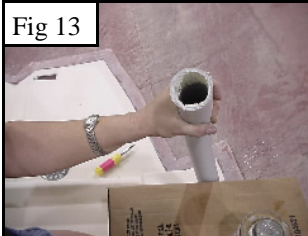

Fig 14



Fig 15

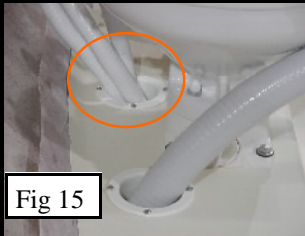

Fig 16

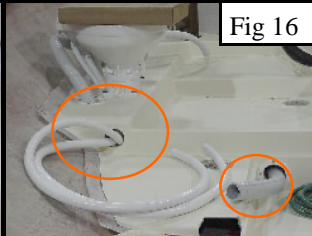

Fig 17

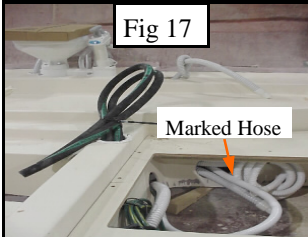

Fig 18



Fig 19



Fig 20

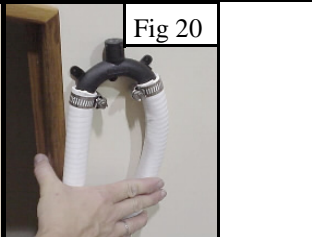

Fig 21



Fig 22



Finished View



Finished View

# 356 SOP GFI OUTLET WIRING

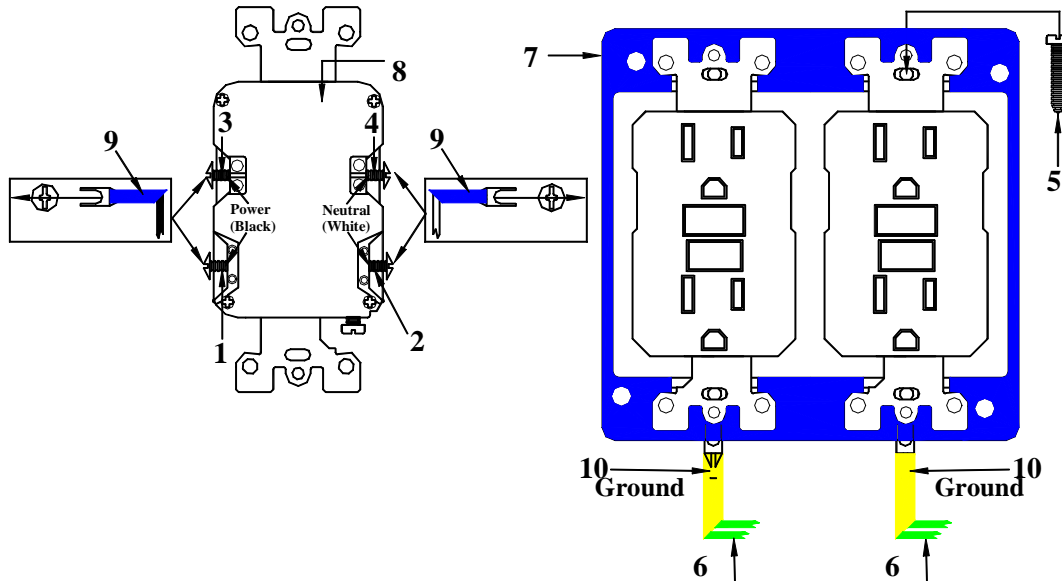

#	#Ea.	Description	Size	Part #	#	#Ea.	Description	Size	Part #
1	2	Panel to GFI Wire (Black)	14-3	653100	6	4	Ground Wires (Green)	14-3	653100
2	2	Panel to GFI Wire (White)	14-3	653100	7	1	Duplex Outlet Plastic Box	N/A	251425
3	2	GFI To Outlets Wire (Black)	14-3	653100	8	2	GFI Outlet	N/A	251758
4	2	GFI To Outlets Wire (White)	14-3	653100	9	8	Blue Wire Terminal	N/A	257714
5	4	GFI Fasteners	Comes	With Outlet	10	2	Yellow Wire Terminal	N/A	257732
					11	1	Double Receptacle Cover	N/A	250850

- The two GFI outlets will be located in the duplex box that goes into the forward face of the chart locker upper cabinet. The starboard-forward outlets wire and the port outlets wire coming from the panel then looping back down will need to be cut and wired to the outlets. Place the outlet wired to the port outlets wire on the outboard side of the duplex box. The following is the proper way to wire one outlet--wire both outlets following these instructions.
- Cut thru the romex at the top of the loop then slit the romex sheathing back approximately 3" and pull the ground (green) wires out of the sheathing. Push all of the wires except the ground wires thru the back of the plastic outlet box.
- Strip all the wires in the romex back 5/8".
- Attach both of the ground wires (green) to a yellow wire terminal then leave them hanging outside of the plastic box. These will be attached to the screw that holds the outlet to the outlet box later.
- Attach blue wire terminals to the other four wires (one wire per terminal).
- NOTE: For the outlets down line to be protected by the GFI outlet the wires from the panel must be attached to the bottom terminals and the wires going out to the other outlets must be attached to the top terminals.
- Connect the neutral wire (white) from the panel to the bottom silver colored screw on the GFI. (Note: Neutral side and the ground screw are on the same side of outlet.)
- Connect the hot wire (black) from the panel to the bottom brass colored screw on the GFI.
- Connect the outlets hot wire (black) to the top brass colored screw on the GFI (Note: Connect wire to same side as black wire from panel.)
- Connect the outlets neutral wire (white) to the top silver colored screw on the GFI (Note: Connect wire to same side as white wire from panel.)
- Push the wires in back into GFI box.
- Secure the GFI outlet to the box with designated fasteners (remember to attach ground terminal under one screw).
- Place and secure the outlet box into the hole in the cabinet.
- Screw the cover on the outlet box with the screws provided with the cover.

Revision Dates:

Expected Time:

Page

# 356 SOP GALLEY SINK PLUMBING INSTALLATION

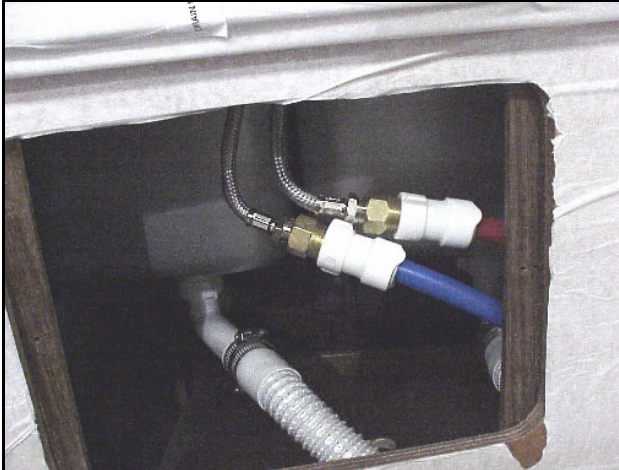
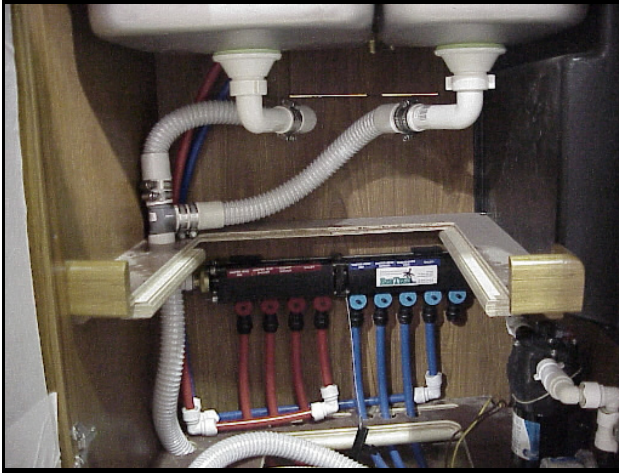

#	Qty.	Description	Size	Part #
1	N/A	Tubing-Cold	15 mm	359045
2	N/A	Tubing-Hot	15 mm	35906
3	2	Adapter	1/2"F-15 mm	355228
4	4	Equal Elbow	15 mm	355228
5	1	Hose Shieldvac	1-1/4" X 6'	358053
6	2	Hose Shieldvac	1-1/4" X 1.25'	358053
7	1	PVC Tee Hose Barb	1-1/4"	354795
8	10	Hose Clamps	#20	353409

1. Place the 6' long hose in the large cutout of the bottom shelf. Run the hose up thru the hole on the port side of the bottom shelf then the top shelf enough so it can be attached to one of the inline ends of the PVC tee. Attach the hose to the tee using two designated hose clamps.
2. Attach one end of the two 1.25' long drain hoses to the two drain elbows on the bottom of the sink using two designated clamps on each hose. Attach the left hose (portside) to the top of the PVC tee using two designated hose clamps then attach the other hose to the tee end of the PVC tee using two designated hose clamps.
3. Tighten the drain elbows where they come out of the sink strainer.
4. Remove the panel on the forward side of the galley to have access to the faucet. A 3/8"-1/2" reducer should be on the end of each faucet tube, these are only hand tight and will need to be tighten. Attach a 1/2"- 15mm adapter to the end of each reducer and tighten well.
5. Run a cold & hot water tube down thru the hole in the forward-inboard corner of the top shelf in the galley until it is about 1" above the bottom shelf. Connect an equal elbow onto each tube. Cut the top of the tubes the correct length to attach them to the whale adapters connected to the faucet (the hot water goes inboard) then attach them the adapters.
6. Cut a piece of tubing to run between the elbow on the bottom of the tube going to the faucet and the elbow on the line coming from the manifold. Connect this tube to both elbows. Do this for both the hot and cold water lines

Revision Dates:

Expected Time:

Page



# 356 SOP FLUORESCENT LIGHT INSTALLATION

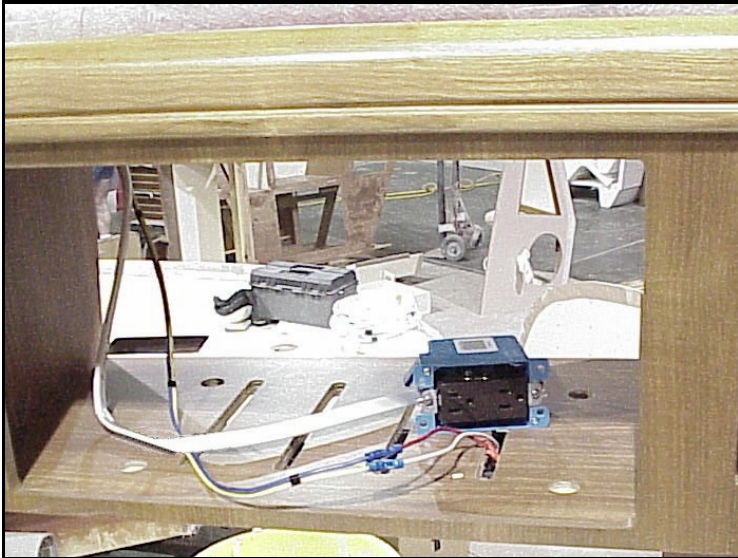

#	Qty.	Description	Size	Part #
1	1	Fluorescent Light	15"	257138
2	2	Light Fastener	#6 X 1/2" P/H	466790
3	2	Butt Connector	Blue	257570
4	1	Flexible Conduit	3/8"	656405

1. The fluorescent light will be located under the microwave compartment in the galley upper cabinet.
2. Snap the cover off the fluorescent light then remove the bulb and the white reflective panel to have access to the mounting holes. Center the light on the ventilation grooves cut into the bottom of the microwave compartment and run the wire up thru the aft groove (this will mean the on/off switch is on the aft end of the light). Secure the light to the cabinet using #6 x 1/2" P/H screws. Replace the reflective panel, bulb and cover.
3. The red wire from the fluorescent light will be attached to the blue wire from the harness using a blue butt connector.
4. The white wire from the fluorescent light will be attached to the yellow wire from the harness using a blue butt connector.
5. Place wires in flexible conduit attach to the back of the shelf.

**Revision Dates:**

**Expected Time:**

**Page**

# 356 SOP SHOWER, VANITY FLOOR & WET LOCKER FLOOR DRAIN INSTALLATION

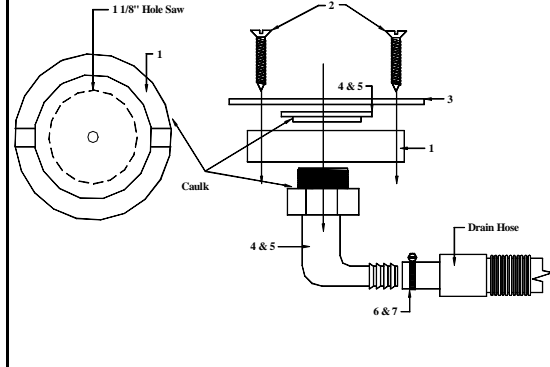
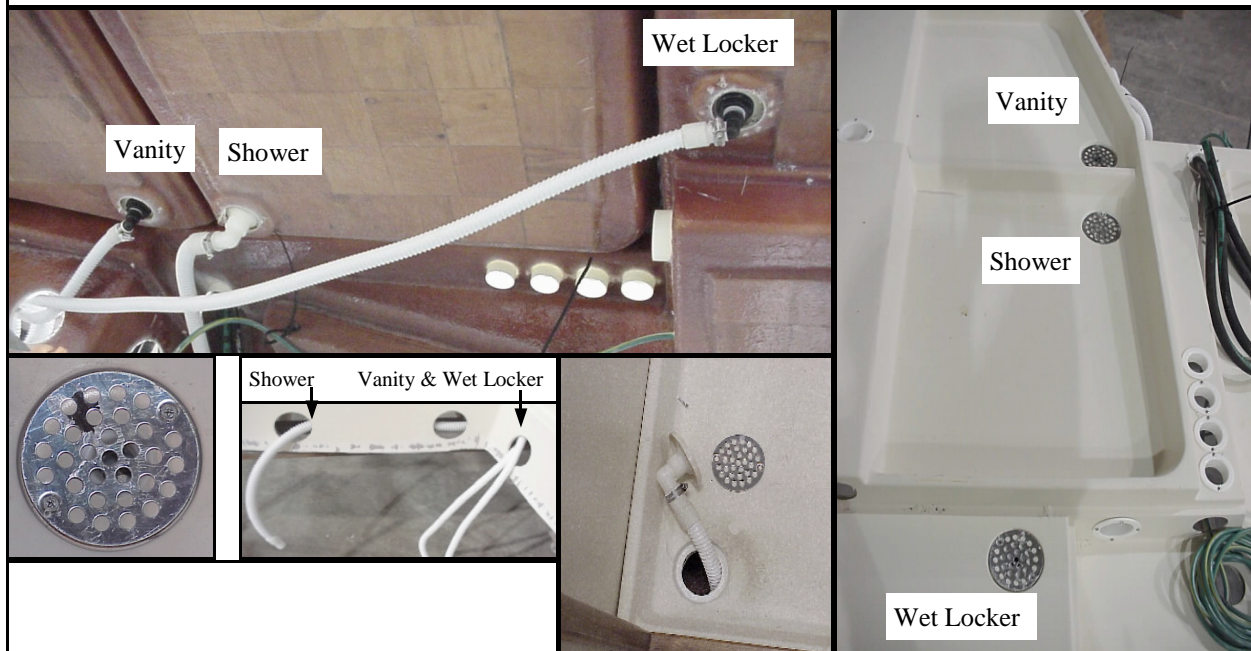

#	#Ea	Description	Size	Part #
1	3	ABS Drain Cover	N/A	256445
2	6	Drain Cover Fasteners	#10 x 1-1/4" F/H	460830
3	3	Drain Strainer	4" SS	350421
4	1	Drain Assembly	1" X 90°	350655
5	2	Drain Assembly	3/4" X 90°	350673
6	1	Hose Clamps	#12	353373
7	2	Hose Clamps	#10	353355

1. Three floor drains are installed in the 356, one in the wet locker area, one in the shower, and one in the vanity area. The installation is the same with the exception that the shower drain will get a 1" drain (attached to the drain hose with a #12 hose clamp) and the wet locker and vanity area will get a 3/4" drain Attached to the drain hoses with a #10 hose clamp).
2. Clean the surfaces of the drain and drain cover with alcohol then caulk both sides of the drain and attach it to the ABS drain cover. Note: For type of caulk see page 1, #3.
3. Attach the drain hose to the bottom of the drain using the designated clamp. Run the other end of the drain hose to the sump pump area.
4. Clean the outside of the drain cover and the drain cover receiver in the shower pan with alcohol then place the ABS drain cover in position so the two indentations are running port to starboard then caulk well to insure there are no leaks. Note: For type of caulk see page 1, #3.
5. Place the drain strainer in position then mark the mounting hole locations (the screws should go thru the indentations).
6. Drill the marked locations using a 1/8" drill bit.
7. Caulk the mounting holes and the drain cover and pan then secure the drain strainer to the drain cover and the pan using the designated fasteners. Note: For type of caulk see page 1, #3.
8. Run the three hoses under the pan. Run the vanity and wet locker hoses and out the forward port hole in the sump pump area, and the shower hose out the forward starboard hole in the sump pump area.

Revision Dates:

Expected Time:

Page 16

# 356 SOP COLD AND HOT WATER HOSE RUNS

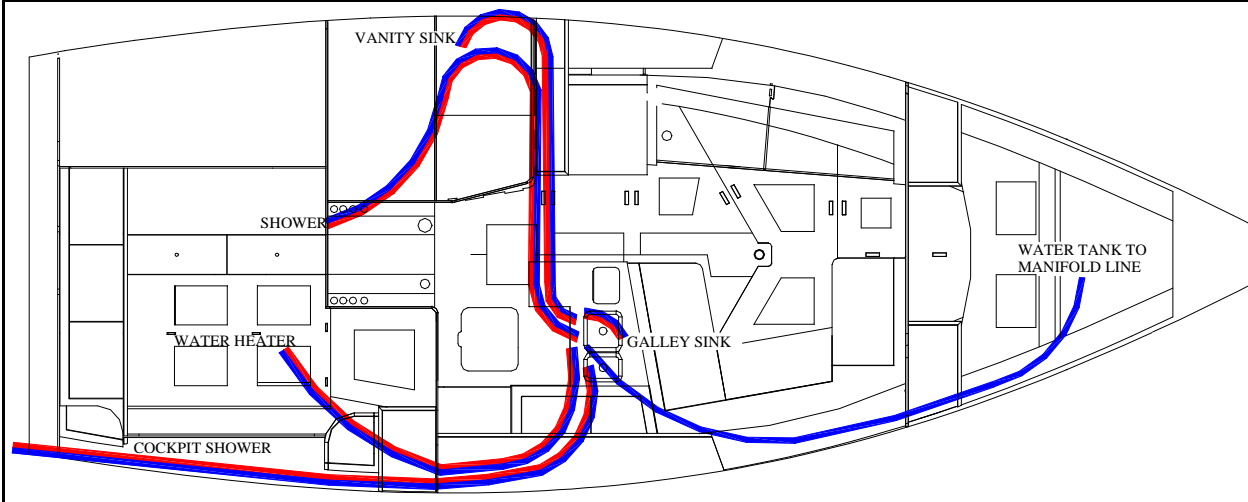

#	Qty.	Description	Size	Part #
1	1	Cold Water Tube (Blue)	15 mm	359045
2	1	Hot Water Tube (Red)	15 mm	359046

1. There will be five sets (one hot line and one cold line) of water lines and one single water line that will all meet under the galley sink so they can be hooked up to the water manifold when it is installed. The five sets are; the galley sink, vanity sink, shower, water heater and cockpit shower. All the sets except the galley sink will need to be color coded by wrapping both ends of the set with colored electrical tape. Use green for the water heater, yellow for the shower, red for the vanity sink and black for the cockpit shower.
2. From the port side of the boat run the shower and vanity sink tubes thru the aft 2" PVC pipe. After coming out of the other end run the tubes thru the cutout in the sub floor, forward of the PVC pipe, so approximately 20" of tubing is sticking out. If the galley has not been installed put the tubing back under the sub floor so it will be out of the way.
3. From the starboard side of the boat run the water heater and the cockpit shower tubes under the galley and up thru the cutout in the sub floor leaving about 20" of tubing above the floor to be hooked up to the manifold later. Run the water heater tubes aft along the outboard edge of the boat then thru the cutouts in the pan just aft of the aft galley bulkhead then inboard to the water heater compartment. Run the cockpit shower tubes aft along the outboard edge of the boat then into the 1-1/2" PVC pipe to the aft end of the boat. Leave approximately 4' of tube to be hooked up to the cockpit shower at a later stage.
4. Run the "water tank to manifold" cold water tube from the v-berth area along the starboard side of the boat into the cutout in the sub floor under the galley sink. Leave about 20" of hose.
5. The galley sink tubes will not be run until the manifold is in place and will be covered under the "Galley Sink" SOP.

Revision Dates:

Expected Time:

Page

# 356 SOP CO MONITOR INSTALLATION

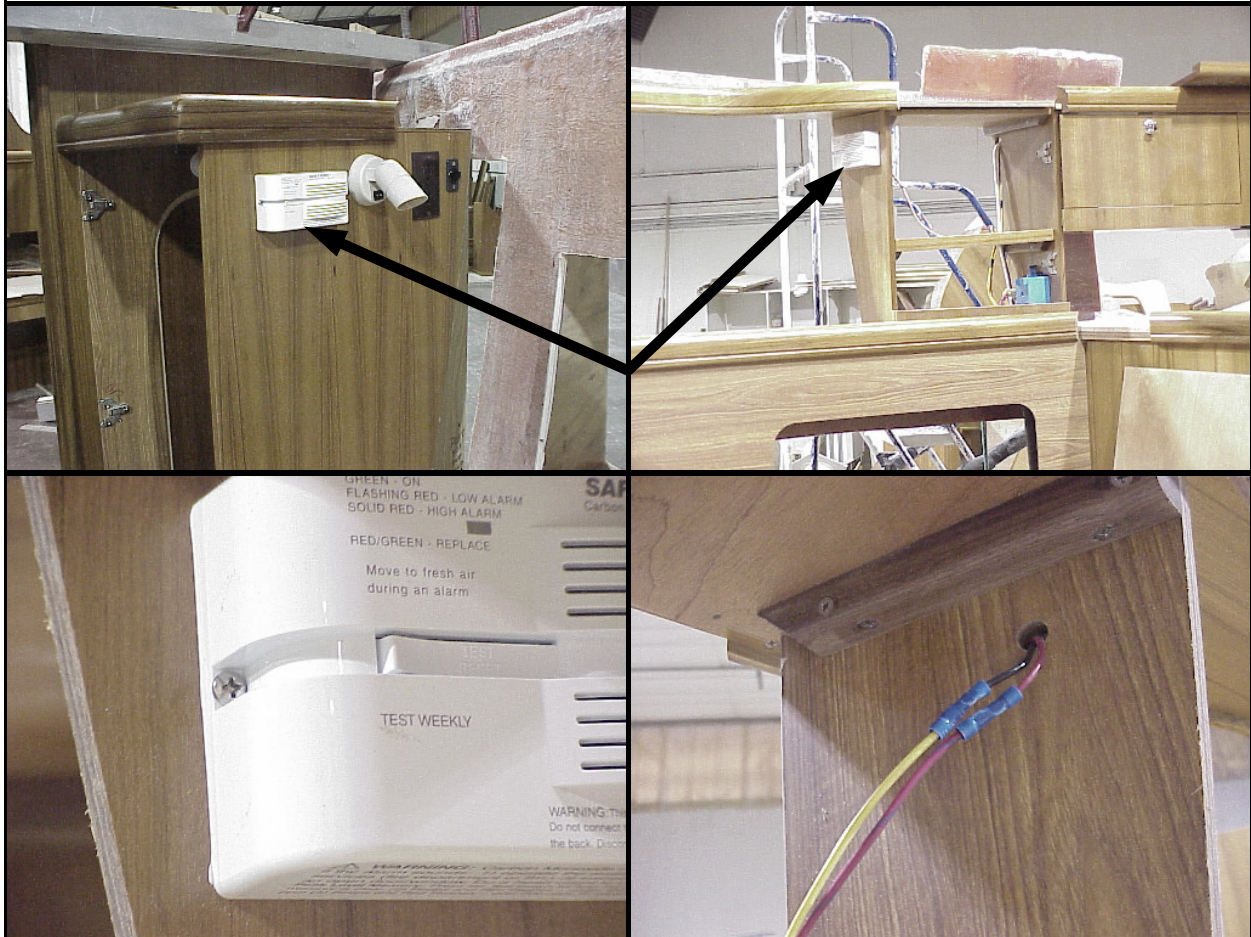

#	Qty.	Description	Size	Part #
1	2	CO Monitor	N/A	353315
2	4	Monitor Fastener	#6 X 5/8" P/H	466870
3	2	Butt connectors	Blue	257570
4	1	Flexible Conduit	3/8"	656405

1. Two carbon monoxide (CO) monitors will be installed in this stage. One will be located on the V-berth port hanging locker, the other will be forward side of the galley upper cabinet.
2. Run the wires from the monitor thru the holes in the furniture then place the monitor on the furniture, making sure it is level, and attach the monitor to the furniture with the designated fasteners.
3. Connect the red wire from the monitor to the red/blue wire from the harness with a blue butt connector.
4. Connect the black wire from the monitor to the yellow wire from the harness with a blue butt connector.
5. Place the wires in 3/8" conduit and attach to the underside of the shelf.

Revision Dates:

Expected Time:

Page

# 356 SOP CHAFE GUARDS INSTALLATION

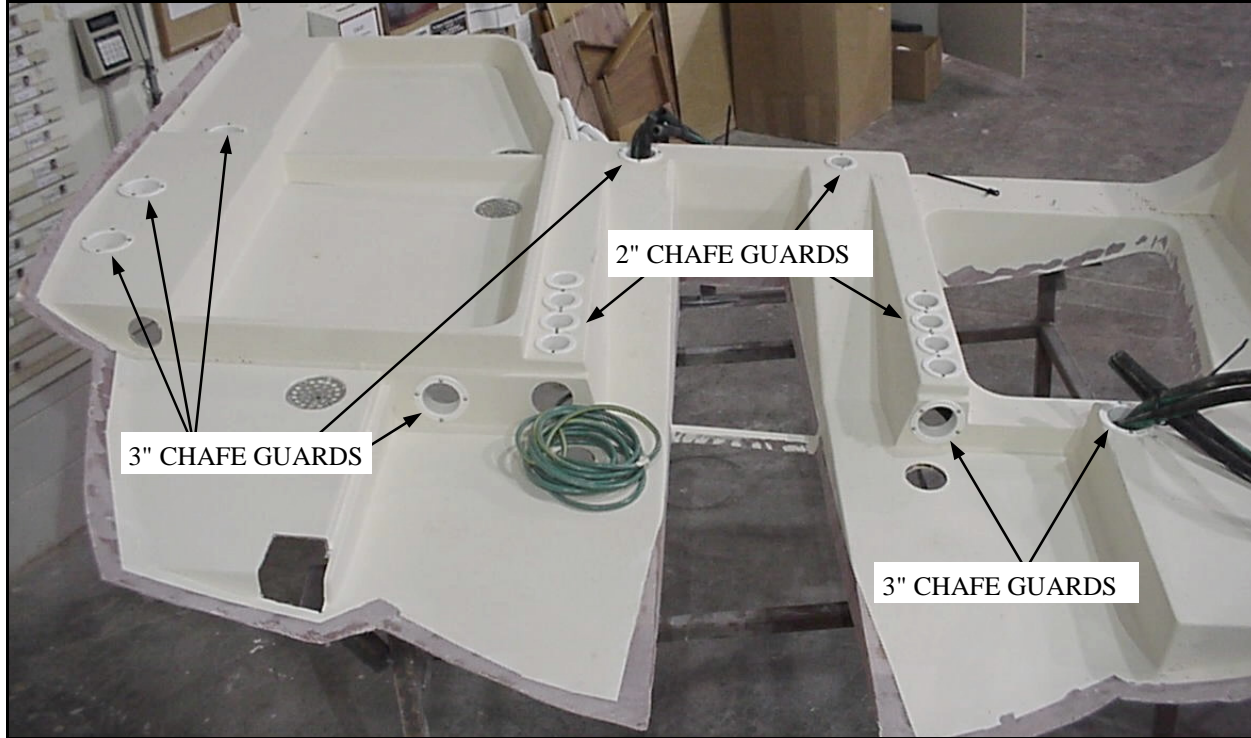

#	Qty.	Description	Size	Part #
1	7	Chafe Guard	3"	314440
2	9	Chafe Guard	2"	314430
3	46	Chafe Guard Fastener	#6 x 5/8" P/H	466870

1. There are two sizes of chafe guards used, 2" and 3". When securing the chafe guards to the pan always use two screws and locate them in the center of the ring on the forward and aft sides.
2. The nine 2" chafe guards will go in the nine 2" holes located (4) port, (4) starboard, and (1) starboard forward of the engine compartment.
3. One of the 3" chafe guards go in the 3" hole at the port forward end of the engine compartment three other 3" chafe guards go into the 3" holes in the pan near the head. Two of the last three 3" chafe guards goes into the port and starboard aft engine compartment and the last 3" chafe guard goes into the forward inboard corner of the heater compartment.
4. Place the chafe guards in position then drill thru the rings and pan with a 1/8" drill bit. The 2" guards get 2 fasteners each and the 3" guards get 4 fasteners each.
5. Secure the chafe guards to the pan using the designated fasteners.

Revision Dates:

Expected Time:

Page

# 356 SOP BUSS BAR & ELECTRIC PANEL WIRING

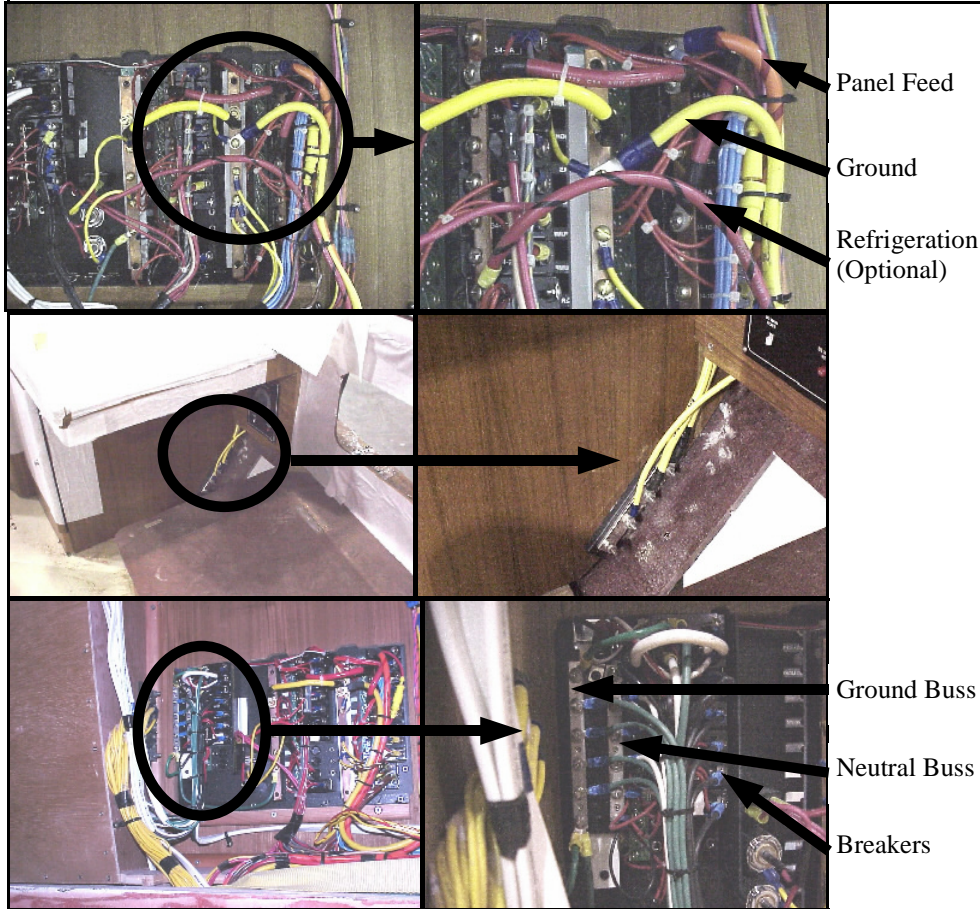

#	Qty.	Description	Size	Part #	#	Qty.	Description	Size	Part #
1	1	Maxibuss	2106B	256745	3	1	Battery Negative	2/0 X 12' (Yellow)	
2	1	Buss Bar Jumper	6 Gauge x 4.5' (Yellow)		3	1	Engine Negative	2 Gauge x 11.5' (Yellow)	

1. The 6 gauge orange/red wire from the harness (#9) is the 12 volt power feed for the electric panel. This wire will be connected to the forward side of the aft-top switch (DC Main). The other end of the wire will be connected to the battery selection switch.
2. The 6 gauge yellow wire from the harness (#8) will be attached to the aft buss bar on the electric panel.
3. The red/black wire from the harness (#?) is for the optional refrigeration unit, if the boat does not have this option tie this wire out of the way. If the boat has this option the wire will be attached to the forward side of the refrigeration switch.
4. The 120 volt wires will be attached to the forward end of the panel. Strip approximately a foot of the romex sheathing off of the wires then strip 5/8" of insulation off the end of the wires and connect a blue eyelet to the end of each wire. The ground wires (green) will be attached to the most forward buss bar. The neutral wires (white) will be connected to the second most forward buss bar. The power wires (black) will be attached to their respective breakers. NOTE: Two wires will be attached to the outlets breaker.
5. The maxibuss will be attached outboard lower corner of the forward chart table support with #10 X 1/2" flathead screws. Attach the battery negative cable, engine negative cable, and the buss bar jumper cable to the maxibuss. Attach the other end of the jumper cable to the buss bar that is attached to the wiring harness. Run the other cable as described in the "Battery & Ground Run" SOP.
6. Tie wrap and secure all wires in a workmanship like manner

<b>Revision Dates:</b>	<b>Expected Time:</b>	<b>Page</b>
------------------------	-----------------------	-------------

# 356 SOP BATTERY SELECTOR SWITCH INSTALLATION

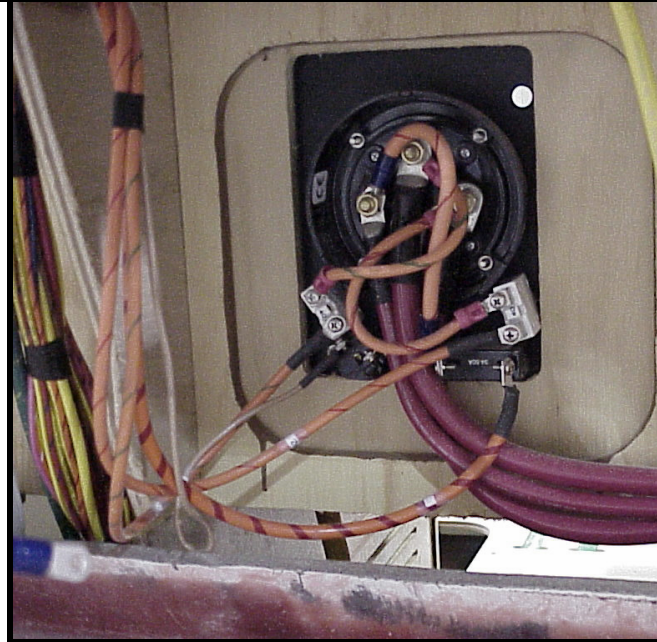
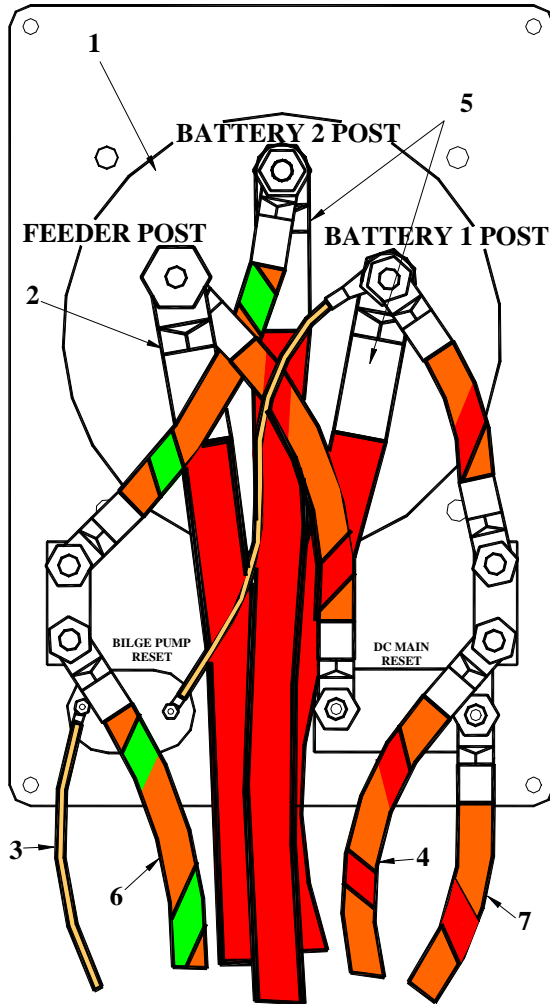

#	#Ea.	Description	Size	Part#
1	1	Battery Selection Switch	N/A	253520
2	1	Red (Power Feed)	2 Gauge X 11.5'	653800
3	1	Tan (Bilge)	16 Gauge	659200
4	1	Orange/Red (Battery)	8 Gauge	658000
5	2	Red (Battery)	2/0 X 12'	653800
6	1	Orange/Green (Battery )	8 Gauge	657800
7	1	Orange/Red Panel Feed	6 Gauge	657900
8	4	Selector Switch Fasteners	#8 x 3/4" B/O	468710

1. The battery selection switch will come with the jumper wires already attached. The engine, battery cables, and wires from the harness will need to be attached. In this SOP the wire will be described by the number in the drawing then if the wires from the harness have a harness number (the number that is actually on the wire) it will be given in parenthesis. Example: The #3 tan wire (#10) will be connected to the left terminal on the bilge pump reset switch. "3" is the number in the drawing and "10" is the number that is taped on the wire. Also, when referring to left and right it will be as you are looking at the back of the battery selection switch.
2. Attach one of the battery cables, #5, (2/0 X 12') to the #1 battery post and the other battery cable, #5, (2/0 X 12') to the #2 battery post on the back of the battery selection switch.
3. Attach the engine cable, #2, (2 gauge X 11.5') to the feeder post on the back of the battery switch.
4. Attach the #3 tan wire (#10) from the harness to the left terminal on the bilge reset switch.
5. Attach the #6 orange/green wire (#11) to the lower terminal on the left breaker.
6. Attach the #4 orange/red (#12) to the lower terminal on the right breaker.
7. Attach the #7 orange/red (#9) to the right terminal on the DC main reset switch.
8. Place the battery selection switch in position under the chart locker and secure it using the designated fasteners.

Revision Dates:

Expected Time:

Page

# 356 SOP BATTERY CHARGER INSTALLATION

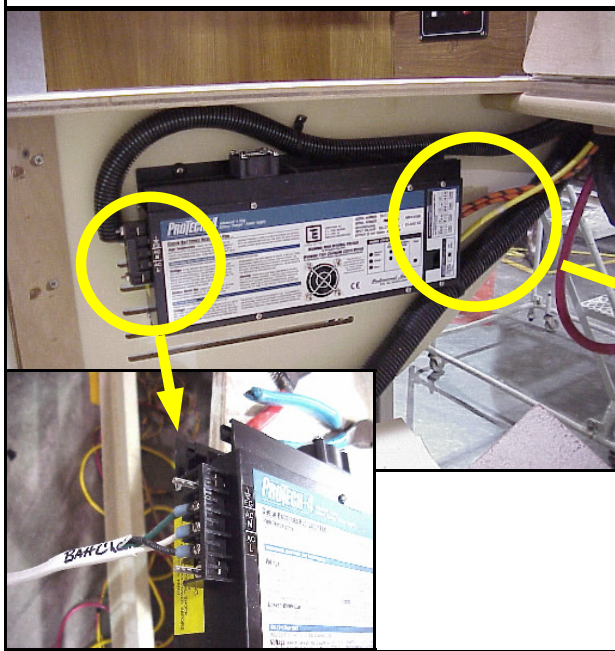
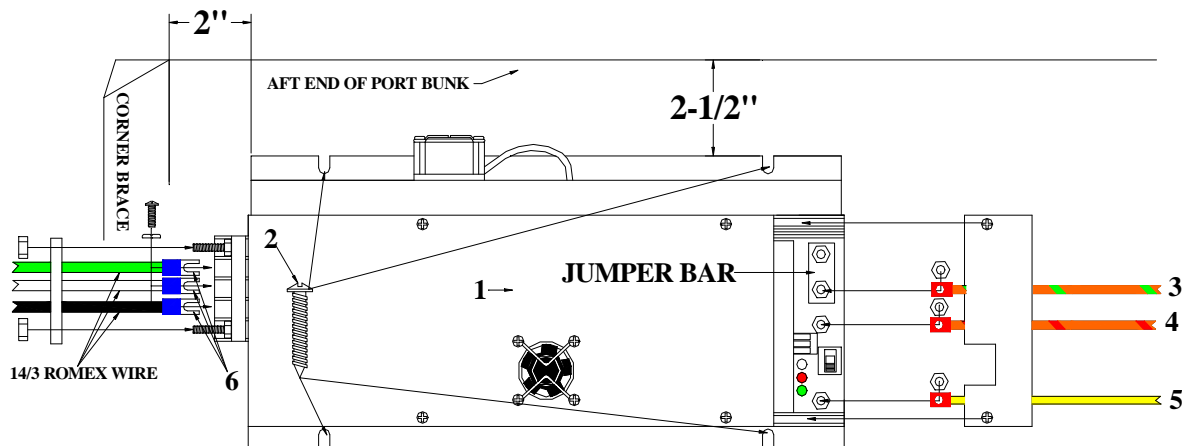

#	Qty.	Description	Size	Part #
1	1	Battery Charger	110/220	254315
2	4	Battery Charger Fasteners	#10 x 1/2" PH	466509
3	1	Orange/Green Wire	8 Gauge	657800
4	1	Orange/Red Wire	8 Gauge	658000
5	1	Yellow Wire	8 Gauge	653615
6	3	Blue Spade Connectors		

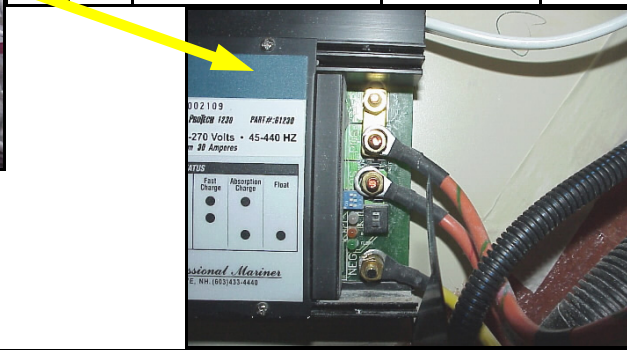

1. Strip the outer sheathing on the battery charger romex back 2" to 3" then strip the insulation on each wire back 5/8" and attach a blue spade connector to each wire.
2. Connect the green (ground) wire from the romex to the "FG" connector on the inboard end of the battery charger.
3. Connect the white (neutral) wire from romex to the "N" connector on the inboard end of the battery charger.
4. Connect the black (power) wire from romex to the "L" connector on the inboard end of the battery charger.
5. Connect the yellow wire from the harness to the designated connector on the outboard side of battery charger.
6. Make sure the jumper bar that comes with the charger is between the top two positive posts is in place.
7. Connect the orange/red wire from the harness to the designated connector on the outboard side of the battery charger.
8. Connect the orange/green wire from the harness to the designated connector on the outboard side of the battery charger.
9. Place the battery charger inside the port bunk on the aft face so it is 2-1/2" down from the top and 2" outboard from the corner brace of the bunk. Mark the mounting hole locations.
10. Remove the battery charger and drill the marked locations using a 5/32" drill bit (do not drill all the way thru the bunk).
11. Secure the battery charger to the bunk using the #10 x 1/2" panhead fasteners.
12. Wrap flexible conduit around the romex then secure it to the bunk face with a tie-wrap and #6 X 1/2" panhead screw.

Revision Dates:

Expected Time:

Page



# 356 SOP BATTERY AND ENGINE PVC PIPE INSTALLATION

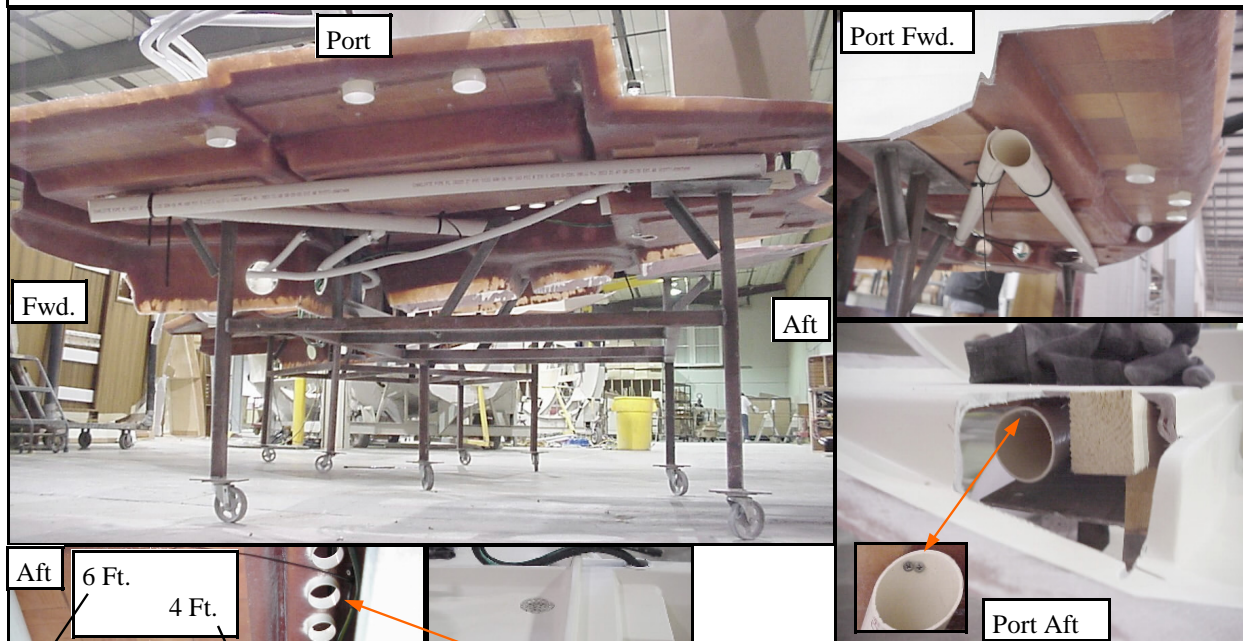

#	Qty.	Description	Size	Part #
1	1	Engine PVC Pipe	1-1/2" x 4 ft.	
2	1	Battery PVC Pipe	2" x 6 ft.	
3	5	PVC Fasteners	# 10 x 3/4" F H	461550
4	3	Tie Wraps	15" with Eyes	460250

1. The engine and battery cables will run in and thru the designated PVC pipes, located under the port sub floor and pan.
2. The engine PVC pipe is 4 ft. long, place the pointed angle on the pipe to the bottom side of the pan. The pipe is placed at an angle with the fwd end pointed to the port fwd corner cutout and the aft end pointed to the second wire chase hole, see picture.
3. Tie wrap the pipe to the pan using designated tie wraps one on each end of the pipe.
4. The battery PVC pipe is 6 ft. long, place the pointed angle on the pipe to the bottom side of the pan. The pipe is placed with the fwd end pointed to the port fwd corner cutout and the aft end pointed to the port aft cutout.
5. Drill two holes in the aft end of the pipe using a 5/32" drill bit.
6. Secure aft end of the pipe using designated fasteners.
7. Tie wrap the pipe to the pan using designated tie wrap on the fwd end of the pan.
8. The engine and battery cables will be installed later.

Revision Dates:

Expected Time:

Page

# 356 BATTERY & GROUND WIRES INSTALLATION

	1	Engine Negative Yellow, 2 GA, 11.5'
	2	Engine Positive Red, 2 GA, 11.5'
	3	#1 Battery Positive Red, 2/0, 12'
	4	Battery Negative Yellow, 2/0, 12'
	5	#2 Battery Positive Red, 2/0, 12'
	6	Starboard Chainplate Ground Green/Yellow, 4 Ga, 12'
	7	Port Chainplate Ground Green/Yellow, 4 Ga, 12'
	8	Radar Arch Ground Green/Yellow, 4 Ga, 32'

1. The engine and battery cables (#1- #5) will start under the electric panel area and run aft under the sub floor and pan in and thru the PVC pipes on the port underside of the pan. The positive cables (red) will be hooked to the battery selection switch later (see "Battery Selection Switch" SOP). The negative cables (yellow) will be hooked to the buss bar under the chart locker table.
2. The engine cables are smaller in diameter than the battery cables (2 gauge as opposed to 2/0). Run the engine cables, #1 & #2, aft and inboard through the 4 ft. PVC pipe then up thru the forward 2" chafe guard on the portside of the engine compartment.
3. Run the battery cables; #3, #4, & #5, aft and slightly inboard through the 6 ft. PVC pipe then up thru the hole in the aft-outboard corner of the pan. Attach the cables to the aft side of the wet locker with a tie-wrap, also secure the cables to the bottom of the pan with tie-wraps.
4. The starboard and port chainplate have a large eyelet on one end and a smaller eyelet on the other end, the small eyelet will be in the center of the boat and the larger eyelets will be on the outboard edge of the boat. Run the small eyelet end of the cables thru the respective ends of the PVC pipe in the center of the boat and come out of the hole in the middle of the pipe. Roll up the cables and attach them to the sub floor with a tie-wrap. This end will be attached to the keel in the keeling stage. Run the other ends of the cables up the hull and droop the over the edge of the fabrication module. These ends will be attached to the chainplates in the decking stage.
5. The radar arch ground cable also has a large eyelet on one end and a smaller eyelet on the other end. The smaller eyelet will go forward. Starting at the sump pump area roll up some cable and attach it to the sub floor with a tie-wrap then run the rest of the cable aft under the sub floor then thru the hole in the pan on the forward-port side of the engine compartment. Run aft thru the hole in the pan aft of the engine compartment, this will leave the cable in the port section of the Q-berth bunk. Roll the cable up and leave it there.

Revision Dates:

Expected Time:

Page

# 356 SOP 120V WIRE RUNS

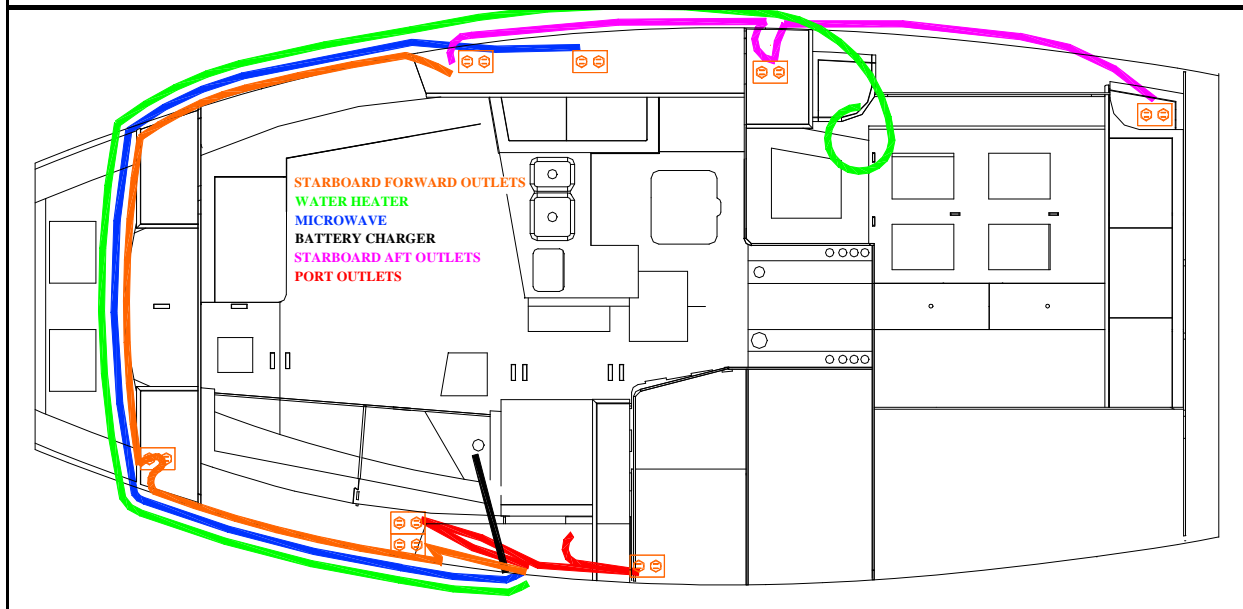

**NOTE: NO BUTT CONNECTORS ARE TO BE USED TO SPLICE THE ROMEX WIRE TOGETHER. IF THE WIRE IS NOT LONG ENOUGH TO REACH FROM THE PANEL TO THE OUTLET OR APPLIANCE THEN THE WIRE MUST BE REMOVED AND REPLACED WITH A LONGER WIRE.**

- The battery charger, microwave, water heater, and starboard & forward outlets wires will be taped together. Take the end with all the wires together and place it behind the electric panel. Run the shortest wire (6' battery charger) down into the aft end of the port bunk (Make sure the wire can reach the top-inboard-aft corner of the bunk with 4" of spare wire). Run the loop (on the starboard & forward outlets wire) up thru the notch in the forward end of the chart locker then to the outlet cutout in the forward face of the aft port upper cabinet. Run the rest of the group down then forward thru the PVC pipe under the port bunk. When the group gets under the port V-berth hanging locker run the other loop (on the starboard & forward outlets wire) up thru the hanging locker and thru the outlet cutout on the forward face of the locker. Continue running the group forward then go to the starboard side of the boat just forward of the V-berth aft support. On the starboard side of the boat run aft thru the hanging locker then under the starboard bunk top. Go up thru the aft end of the backrest with the starboard & forward outlets wire and the microwave wire. Put the starboard & forward outlet wire thru the outlet cutout in the forward end of the upper galley cabinet. Run the microwave wire under the top of the cabinet thru the hole to the microwave compartment. Continue to run the water heater wire aft thru the PVC pipe under the galley icebox then under the pan and come thru the cutout in the aft end of the pan shelf where the Q-berth hanging locker sits (just aft of the aft galley bulkhead).
- Take the starboard aft outlets wire (the single wire with one loop taped) and run the loop up thru the cutout in the pan where Q-berth hanging locker will be placed (just aft of the aft galley bulkhead). Run the shorter leg of the wire (10') forward thru the PVC pipe under the galley icebox then up thru the starboard bunk backrest to the outlet cutout where the end of the starboard & forward outlets wire is. Run the other end of the wire (12') aft thru the 1-1/2" PVC pipe until it comes out of the other end. Leave the wire here.
- Back at the electric panel take the end of the port outlets wire with the 3' loop and leave it behind the panel. Run the loop to the outlet cutout in the forward face of the aft port upper cabinet just as the starboard & forward outlets wire was run. Run the rest of the wire aft under the backrest top then back up thru the cutout in the aft end. Run the small loop thru the outlet cutout in the forward head bulkhead then run the rest of the wire up thru the cutout in the aft-outboard corner of the chart locker. Coil up the rest of the wire and leave on the cabinet top.
- Place the shore power wire on top of the chart locker with the port outlets wire as it will be installed at a later stage.

#	#Ea.	Description	Size	Part #
1	1	Battery Charger	14-3 X 6'	653100
2	1	Microwave	14-3 X 34.5'	653100
3	1	Water Heater	14-3 X 38'	653100
4	1	Starboard & Forward Outlets	14-3 X 44'	653100
5	1	Starboard Aft Outlets	14-3 X 29'	653100
6	1	Port Outlets	14-3 X 28'	653100
7	1	Shore Power	10-3 X 23'	

Revision Dates:

Expected Time:

Page

# 356 12 VOLT WIRING HARNESS RUN INSTALLATION

PAGE 1 OF 2

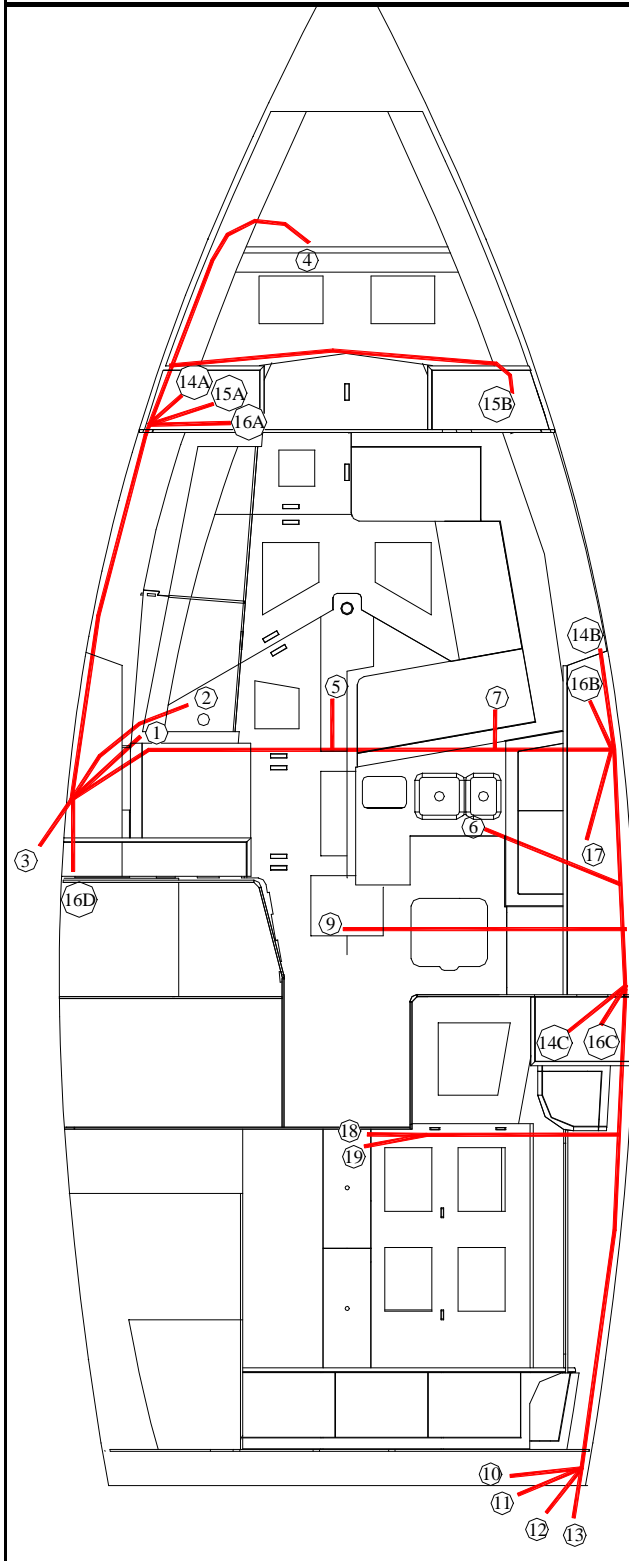

1	Battery Selection & Ground Buss Bar
2	Battery Charger (11,12,13) Orange/Green, Orange/Red, Yellow
3	In Power Panel (two plugs, 1, 8, 9) Red/Black, Yellow, Orange/Red
4	Water Level Indicator (17, 18, 19) Orange/Blue, Pink/Black, Yellow
5	Bilge Pump (5, 6, 7,) Brown/Red, Brown/Orange, Yellow
6	Water Pump (24, 25) Brown, Yellow
7	Refrigeration (1, 2) Red/Black, Yellow
8	L.P.G. (3, 4,) Orange/Red, Yellow
9	Sump Pump (28, 29) Brown/Black, Yellow
10	Blower in Engine (22, 23) Brown/Blue, Yellow
11	L.P.G. (3, 4) Orange/Red, Yellow
12	Waste Level Indicator (14, 15, 16) Orange/Green, Pink/Grey, Yellow
13	Macerator (20, 21) Brown/White, Yellow
14A 14B 14C	Carbon Monoxide Detector: A (32A, 33A), B (Double Wires), C (32, 33) Red/Blue, Yellow
15A 15B	Reading Lights: A (Double Wires), B (46,47) Blue, Yellow
16A 16B 16C 16D	12 Volt Power Outlets: A (34, 35), B (Double Wires), C (36, 37), D (Double Wires) Red, Yellow
17	Fluorescent Light (44, 45) Blue/White, Yellow
18	Fuel Level Indicator (41, 42, 43) Pink, Yellow, Orange/White
19	Vacu-flush Option (38, 39) Brown/Red, Yellow

# 356 WIRING HARNESS RUN INSTALLATION

PAGE 2 OF 2

1. The 12 volt wiring harness will start behind the electrical panel in the chart locker upper cabinet. When referring to a group of wires in this SOP they will be called the by the number in the drawing followed in parenthesis by the numbers on the wires; Ex: #4 (17, 18, 19). Some wires in the harness do not have numbers on them, they are double wires that power an appliance (reading lights, 12 volt outlets, CO monitors, etc.) then continue to power another. In those cases instead of numbers in parenthesis (double "color", double "color") will be used to identify the wires.
2. At the start of the harness (behind the electric panel) the ground buss bar will be attached to the aft side of the divider just forward of the electrical panel, the three plugs (29, 44, 46, 41, 36, 34, 44, 38), (22, 28, 24, 10, 5, 6, 3, 20), & (14, 15, 7, 32, 32, 18) will be left in the panel area and be plugged into the corresponding plugs from the electrical panel. The battery selection wires, #1 (9, 10, 11, 12), will go down to be hooked up to the battery selection switch (see "Battery Selection Installation" SOP).
3. The battery charger wires, #2 (11, 12, 13) will run down into the aft end of the port bunk.
4. The LPG wires, #8 (double orange/red, double yellow) will run under the chart locker table then up into the table to be hooked to the propane panel (see "Propane Panel Installation" SOP). One of the 12 volt outlet wires, #16 (double red, double yellow) will run aft to the forward head bulkhead, the (double blue, double yellow) wire will stay behind the electric panel.
5. The water level indicator wires, #4 (17, 18, 19); CO monitor wires, #14A (32A, 33A); reading lights, #15A (double blue, double yellow) & 15B (46, 47); and one of the 12 volt outlets, #16A (34, 35) will run down then forward thru the PVC pipe under the port bunk top. Run #14A, #15A, & #16A up into the forward end of the V-berth port hanging locker. Continue #4 forward under the outboard bond support board and run #15B forward then starboard across the forward side of the aft V-berth support then aft and up into the forward side of the V-berth starboard hanging locker.
6. The rest of the wires in the harness will run starboard thru the 2" PVC pipe with two groups of wires coming out of the holes in the pipe. The bilge pump wires, #5 (5, 6, 7) will come out of the hole in the middle of the pipe and be left in the bilge area. The refrigeration wires, #7 (1, 2) will come out of the hole between the middle hole and the starboard end of the pipe and will be left in the aft end of the starboard bunk. All the other wires will come out of the starboard end of the pipe.
7. Run the water pump wires, #6 (24, 25), under the galley then up into the galley sink cabinet.
8. Run the CO monitor wires, #14B (double red/blue, double yellow); the 12 volt outlet wires, #16B (double red, double yellow); and the fluorescent light wires , #17 (44, 45) up into the forward compartment of the galley upper cabinet. Continue running the fluorescent light wires, #17 (44, 45) aft thru the holes in the top-outboard corners of the cabinet dividers until they reach the microwave compartment.
9. Run the rest of the wires in the harness aft thru the PVC pipe under the galley. After coming out the aft end of the pipe run the sump pump wires, #9 (28, 29) under the sub floor to the sump pump compartment (just forward of the engine box compartment).
10. About 2 feet aft of the end of the pipe run the CO monitor wires, #14C (32, 33) and the 12 volt outlet wires, #16C (36, 37) up thru the cutout in the pan where the Q-berth hanging locker will go (just aft of the aft galley bulkhead). Tie wrap these wires up and attach them to the aft galley bulkhead.
11. Run the rest of the harness wires aft then once inside the Q-berth bunk (where the next PVC pipe starts run the fuel tank level indicator wires, #18 (41, 42, 43) and the vacu-flush option wires, #19 (38, 39) inboard along the aft side of the forward Q-berth support until they are in the fuel tank compartment.
12. Continue running the rest of the wires in the harness; #10 (22, 23), #11 (3,4), #12 (14, 15, 16), and #13 (20, 21) aft thru the 1-1/2" PVC pipe and leave them aft of the aft kickboard.
13. Wrap wires (include the 120 volt wires when appropriate) in the proper sizes flexible conduit then tie wrap the wire so they will be secure and not fall in the way when the module is lifted and put into the hull.

Revision Dates:

Expected Time:

Page

## 356 SOP 12 VOLT OUTLET INSTALLATION

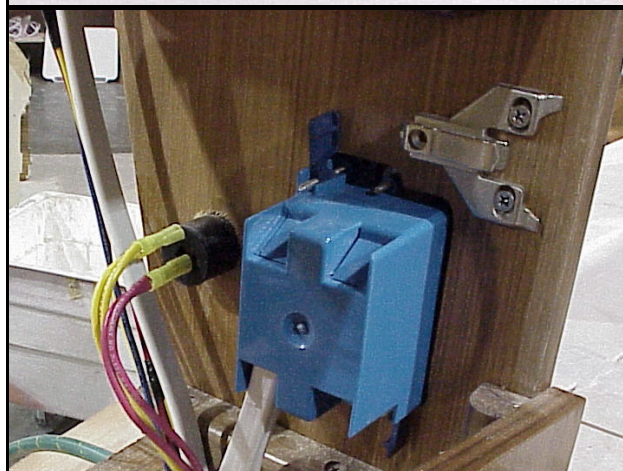

#	Qty.	Description	Size	Part #
1	4	12 V Outlets		255515
2	4	12 V Outlets Fastener	#8 X 5/8" F/H	461870

1. There are four 12 volt outlets in the boat. They are located in the V-berth port hanging locker, the upper galley cabinet, the vanity area, and the Q-berth hanging locker. Only the V-berth hanging locker and upper galley cabinet ones will be mounted in this stage.
2. Prepare the outlets by placing the ring on the cover over the back of the outlet body so the rubber "hinge" will fit into the notch on the body when the cover is closed then close the cover.
3. For the hanging locker and the upper galley cabinet pull the outlet wires from the harness (red, yellow) thru the appropriate hole.
4. Attach the yellow wire from the harness to the outside terminal on the back of the outlet. Attach the red wire from the harness to the center terminal on the back of the outlet.
5. Place the outlet into the hole so the hinge part of the cover is facing outboard and the outlet is not crooked. Secure the outlet to the furniture with the designated fasteners.
6. For the other two outlets plug the wires into the terminals on the outlet then leave the vanity outlet in the electric panel area and the Q-berth hanging locker outlet hanging off the wires that are temporarily attached to the aft galley bulkhead.