

36

SCHEMATICS

12/1/2005

INDEX

PAGE

3. *DC Panel*
4. *DC Panel Schematic*
5. *DC Panel Connectors*
7. *AC Panel*
8. *AC Panel Schematic*
9. *Misc. Harness Adapters*
10. *AC Panel for Air and Generator*
11. *AC Panel Air/Gen Schematic*
12. *Hull Harness*
13. *Hull Harness List*
14. *Hull Harness Connectors*
15. *Deck Harness*
16. *Deck Harness List*
17. *Deck Harness Connectors*
18. *Misc. Wire Kits*
24. *Auto Fire System Schematic*
25. *High Water Pump System Schematic*

SYMBOL	REVISIONS	DATE	ENG

LIST OF DETAILS TO BE INCLUDED WITH PANEL.

- 20 AMP RESET WIRED TO A HOT BUS THEN TO 12VDC OUTLETS THEN TO PLUG
- TWO 12VDC OUTLETS.
- WIRE PANEL WITH PLUGS.
- PREWIRE PANEL FOR OPTIONAL EQUIPMENT.
- HINGE WITH MOUNTING SCREW HOLES
- BACK LIGHTING OF LABELS AND VOLT METER
- SUPPLY WIRES FOR BACK LIGHTING AC SUB PANEL,
- USE SPADE CONNECTORS FOR EASY CONNECTIONS.
- WIRE MACERATOR TOGGLE SWITCH TO MACERATOR BREAKER.
- 5 AMP RESET WIRED HOT TO THE BILGE CIRCUIT FOR CO ALARMS.

BREAKER LIST TO BE SUPPLIED WITH PANEL.

- CABIN LIGHTS :20 AMPS
- LP GAS : 5 AMPS
- REFRIGERATOR :15 AMPS
- TANK INDICATOR : 5 AMPS
- WATER PUMP :10 AMPS
- SUMP PUMP :10 AMPS
- BLOWER :10 AMPS
- STEREO :10 AMPS
- MACERATOR :20 AMPS
- ANCHOR LIGHT : 5 AMPS
- STEAMING LIGHT : 5 AMPS
- RUNNING LIGHTS :10 AMPS
- VHF RADIO :10 AMPS
- INSTRUMENTS : 5 AMPS
- TV/DVD :NDNE
- HEAD :NDNE
- SPARE :NDNE

NOTE:

- PANEL MATERIAL - 1/8" ALUMINUM
- PANEL COLOR/FINISH - FLAT CARBON BLACK WITH GLOSSY BLACK BORDER
- BACK LIGHTING COLOR - BLUE
- BREAKER INDICATOR LIGHTS - RED LED
- BREAKER HANDLE COLOR - BLACK
- TOGGLE SWITCHES INDICATORS - RED
- ADD HINGE TO BOTTOM OF PANEL.
- SEE ELECTRICAL SCHEMATIC FOR BACKSIDE

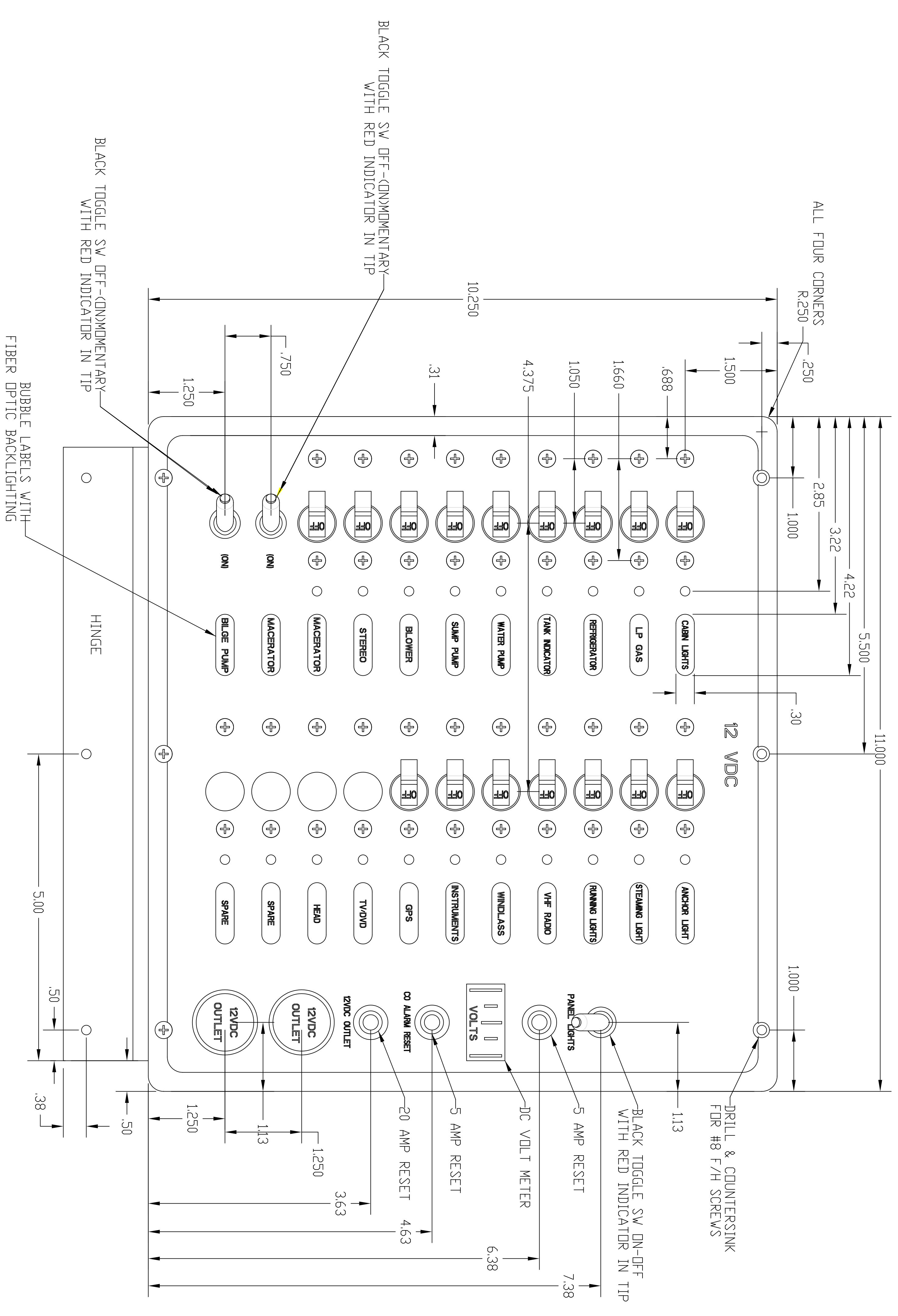

PROJECT: 2004 MODEL YEAR FOR H306/H326/H33/H36

 DRAWING TITLE: 12VDC PANEL

 DRAWN BY: JLK

 DATE: 15-Apr-2003

 SHEET 1 OF 1

 SCALE: 1:1000

 NUMBER: 00051001A

DC PANEL CONNECTORS for 306, 326, 33 & 356

All connectors to be female pins with male connectors.

REV. E
11/20/2003

CONN. A	WIRE# (HULL)	WIRED TO ON PANEL	CONN. TYPE
1	#34, 14ga Red, 12V OUTLET	12VDC OUTLET RESET	Deutsch - DTP Series - 4pin
2	#36, 14ga Red, 12V OUTLET	12VDC OUTLET RESET	
3	#5, 12ga Brown/Red, BILGE MANUAL	BILGE TOGGLE SWITCH	
4	#10, 12ga Tan, BILGE POWER	BILGE TOGGLE SWITCH	

CONN. B	WIRE# (HULL)	WIRED TO ON PANEL	CONN. TYPE
1	#44, 14ga Blue, CABIN LIGHTS	CABIN LIGHT BREAKER	Deutsch - DT Series - 6 pin
2	#46, 14ga Blue, CABIN LIGHTS	CABIN LIGHT BREAKER	
3	#3, 16ga Orange/Red, LPG	LP GAS BREAKER	
4	#32, 16ga Red/Blue, CO ALARM	CO ALARM RESET	
5	#32A, 16ga Red/Blue, CO ALARM	CO ALARM RESET	
6			

CONN. C	WIRE# (HULL)	WIRED TO ON PANEL	CONN. TYPE
1	#20, 10ga Brown/White, MACERATOR	MACERATOR BREAKER	Deutsch - DTP Series - 4pin
2	#24, 12ga Brown, WATER PUMP	WATER PUMP BREAKER	
3	#28, 12ga Brown/Black, SUMP PUMP	SUMP PUMP BREAKER	
4	#22, 12ga Brown/Blue, BLOWER	BLOWER BREAKER	

CONN. D	WIRE# (HULL)	WIRED TO ON PANEL	CONN. TYPE
1	#1, 10ga Red/Black, REFRIGERATOR	REFRIGERATOR BREAKER	Deutsch - DTP Series - 2pin
2	#38, 10ga Brown/Pink, HEAD	branches to HEAD location on panel, but not connected	

CONN. E	WIRE# (PANEL TO PANEL)	WIRED TO ON PANEL	CONN. TYPE
1	16ga Blue, PANEL LIGHTS	PANEL LIGHT BREAKER	Deutsch - DT Series - 2 pin
2	16ga Yellow, PANEL LIGHTS (-)	DC NEGATIVE BUS	

CONN. F	WIRE# (DECK)	WIRED TO ON PANEL	CONN. TYPE
1	#1, 16ga Blue, MAIN LIGHTS	CABIN LIGHT BREAKER	Deutsch - DT Series - 12 pin
2	#3A, 16ga Blue, FORWARD LIGHTS	CABIN LIGHT BREAKER	
3	#5A, 14ga Gray/Red, ANCHOR LIGHT	ANCHOR LIGHT BREAKER	
4	#6A, 14ga Gray/Green, STEAMING LIGHT	STEAMING LIGHT BREAKER	
5	#13, 16ga Blue, PORT AFT LIGHTS	CABIN LIGHT BREAKER	
6	#28A, 16ga Red/White, VHF PWR	VHF RADIO BREAKER	
7	#11, 16ga Blue, STBD LIGHTS	CABIN LIGHT BREAKER	
8	#15, 16ga Gray/Yellow, STERN LIGHT	RUNNING LIGHTS BREAKER	
9	#19, 16ga Blue/White, ARCH LIGHT	CABIN LIGHT BREAKER	
10	#25, 16ga Gray/White, BOW LIGHT	RUNNING LIGHTS BREAKER	
11	#27, 16ga Tan, WINDLASS	WINDLASS BREAKER	
12	#16, 16ga Red/Black, GPS	GPS BREAKER	

CONN. G	WIRE# (TO TANK MONITOR)	WIRED TO ON PANEL OR OTHER	CONN. TYPE
1	#53, 16ga Red/Orange, TANK MONITOR (+)	TANK DISPLAY BREAKER	Deutsch - DT Series - 2 pin
2	#54, 16ga Yellow, TANK MONITOR (-)	DC NEGATIVE BUS	

CONN. S	WIRE# (STEREO PWR)	WIRED TO ON PANEL	CONN. TYPE
1	#50, 16ga Red, STEREO PWR	STEREO BREAKER	Deutsch - DT Series - 3 pin
2	#51, 16ga Yellow/Red, STEREO MEMORY	center post bilge toggle switch with #5 brown/red wire	
3	#52, 16ga Yellow, STEREO (-)	DC NEGATIVE BUS	

	WIRE#	WIRED TO ON PANEL	
	#55, 16ga Blue, CHART LIGHT (+)	CABIN LIGHT BREAKER, 66" total length	blue butt splice
	#56, 16ga Yellow, CHART LIGHT (-)	DC NEGATIVE BUS, 66" total length	blue butt splice

SYMBOL	REVISIONS	DATE	ENG

LEGEND

- = 8ga wire
- = 18-14ga wire
- 10ga marked as shown.

NOTE: ALL INDICATOR LIGHTS NEUTRAL WIRES CONNECTS TO LINE 1 NEUTRAL BUS UNLESS SPECIFIED.

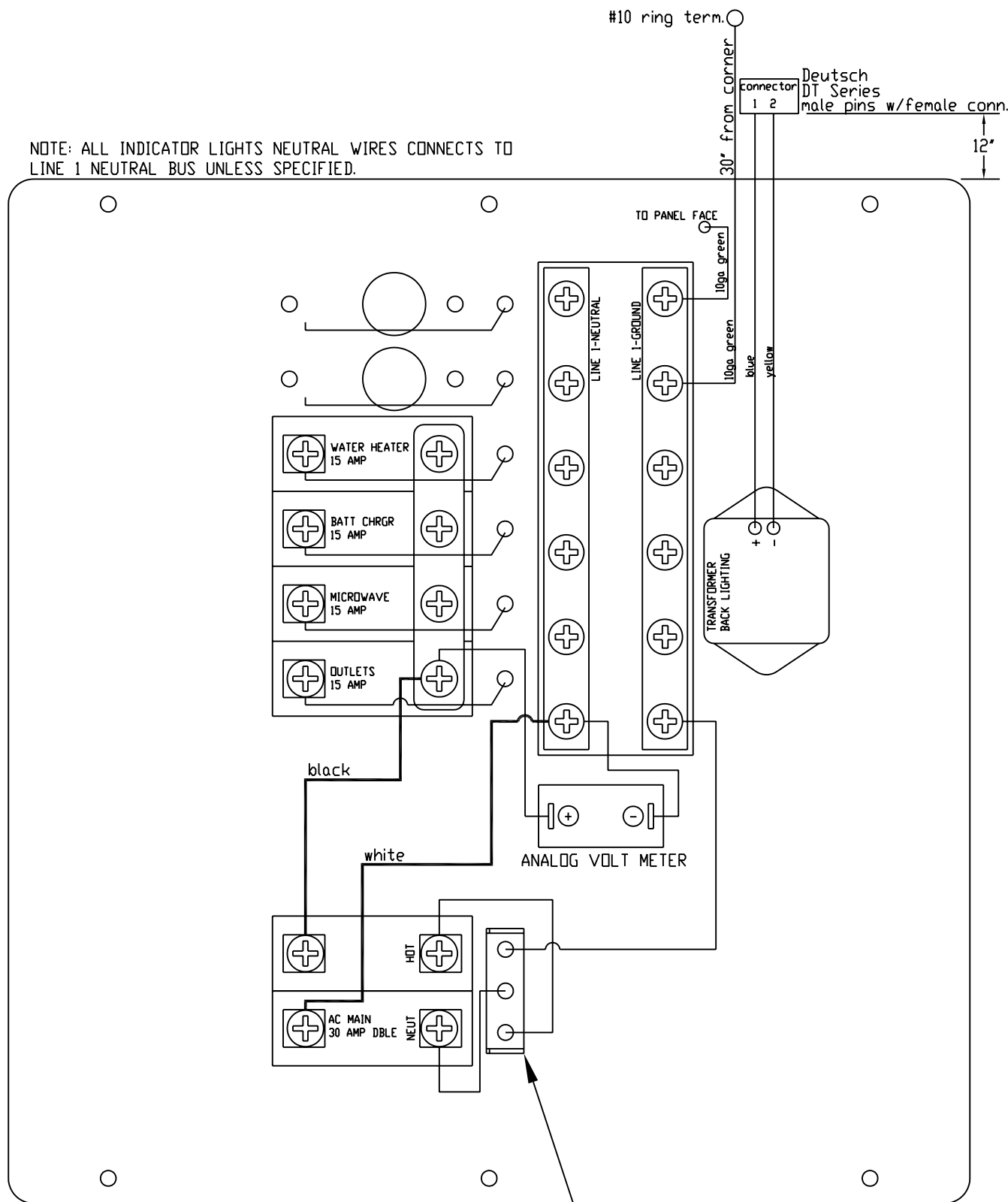

BREAKER LIST FOR 120V PANEL -

- AC MAIN - 30 AMP
- OUTLETS - 15 AMP
- MICROWAVE - 15 AMP
- BATTERY CHARGER - 15 AMP
- WATER HEATER - 15 AMP

BREAKER LIST FOR 230V PANEL -

- AC MAIN - 15 AMP
- OUTLETS - 10 AMP
- MICROWAVE - 10 AMP
- BATTERY CHARGER - 10 AMP
- WATER HEATER - 10 AMP

NOTE:

1. THIS SCHEMATIC MAYBE USED WITH DWG #00051002A AND #00051004A.
2. WIRES MUST BE UNIFORM AND TIE-WRAPED AS NEEDED.
3. SOME COMPONENTS SHOWN MAY NOT BE EXACT.
4. ALL DIMINSIONS IF ANY ARE IN INCHES.

PROPRIETARY INFORMATION: THIS DRAWING CONTAINS INFORMATION FOR WHICH HUNTER MARINE CORPORATION HAS PROPRIETARY RIGHTS.



HUNTER GEN

DRAWING TITLE:

STD AC PANEL SCHEMATIC

DRAWN BY:	JLK	DATE:	17-Dec-03	SHEET	1	OF	1
SCALE:	0.625	HUNTER PART NO.	TBD	REVISION	-	DRAW #	00051002A-SCH

CHECKED:

CONN. T	TANK MONITOR ADAPTER	MATCHES	CONN. TYPE
1	pink, FUEL SENSOR (S)	#41, 16ga pink, FUEL SENSOR (S)	Deutsch - DT Series - 6 pin male connector w/female pins
2	orange/white, FUEL SENSOR (+)	#43, 16ga orange/white, FUEL SENSOR (+)	
3	orange/green, WASTE SENSOR (+)	#14, 16ga orange/green, WASTE SENSOR (+)	
4	pink/gray, WASTE SENSOR (S)	#15, 16ga pink/gray, WASTE SENSOR (S)	
5	orange/blue, WATER SENSOR (+)	#17, 16ga orange/blue, WATER SENSOR (+)	
6	pink/black, WATER SENSOR (s)	#18, 16ga pink/black, WATER SENSOR (s)	
CONN. G			
1	red/blue, TANK MONITOR (+)	#53, 16ga red/orange, TANK MONITOR (+)	DT Series - 2 pin female connector w/male pins
2	yellow or black, TANK MONITOR (-)	#54, 16ga yellow, TANK MONITOR (-)	

CONN. S	STEREO ADAPTER	MATCHES	CONN. TYPE
1	RED, STEREO PWR	#50, 16ga red, STEREO PWR	Deutsch-DT 3 pin female connector w/male pins
2	YELLOW, STEREO MEMORY	#51, 16ga yellow/red, STEREO MEMORY	
3	BLACK, STEREO (-)	#52, 16ga yellow, STEREO (-)	
CONN. SS			
1	WHITE	#9, 16ga white/orange, PORT MAIN SPEAKER (+)	Deutsch - DT Series - 8 pin male connector w/female pins
2	WHITE/BLACK	#10, 16ga white/yellow, PORT MAIN SPEAKER (-)	
3	GREEN	#21, 16ga white/pink, PORT ARCH SPEAKER (+)	
4	GREEN/BLACK	#22, 16ga white/yellow, PORT ARCH SPEAKER (-)	
5	PURPLE	#23, 16ga white/gray, STBD ARCH SPEAKER (+)	
6	PURPLE/BLACK	#24, 16ga white/black, STBD ARCH SPEAKER (-)	
7	GRAY	#30, 16ga white/blue, STBD MAIN SPEAKER (+)	
8	GRAY/BLACK	#31, 16ga white/black, STBD MAIN SPEAKER (-)	

CONN. Arch	ARCH HARNESS	MATCHES	CONN. TYPE
1	16ga blue/white, ARCH LIGHT	#19, 16ga blue/white, ARCH LIGHT	Deutsch - DT Series - 6 pin male connector w/female pins
2	16ga yellow, ARCH LIGHT (-)	#20, 16ga yellow, ARCH LIGHT (-)	
3	16ga white/pink, PORT ARCH SPEAKER (+)	#21, 16ga white/pink, PORT ARCH SPEAKER (+)	
4	16ga white/yellow, PORT ARCH SPEAKER (-)	#22, 16ga white/yellow, PORT ARCH SPEAKER (-)	
5	16ga white/gray, STBD ARCH SPEAKER (+)	#23, 16ga white/gray, STBD ARCH SPEAKER (+)	
6	16ga white/black, STBD ARCH SPEAKER (-)	#24, 16ga white/black, STBD ARCH SPEAKER (-)	

SYMBOL	REVISIONS	DATE	ENG

- NOTE:
1. PANEL MATERIAL - 1/8" ALUMINUM
 2. PANEL COLOR/FINISH - FLAT CARBON BLACK
 3. BACK LIGHTING COLOR - BLUE
 4. AC MAIN INDICATOR - GREEN USING NEON BULB
 5. REVERSE POLARITY INDICATOR - RED USING NEON BULB
 6. BREAKER HANDLE COLOR - RED LED
 7. ADD HINGE TO BOTTOM OF PANEL.
 7. SEE ELECTRICAL SCHEMATIC FOR BACKSIDE

BREAKER LIST TO BE SUPPLIED WITH PANEL FOR 120V-60 HERTZ VERSION.

- AC MAIN :30 AMP, DOUBLE
- GENERATOR :50 AMP, DOUBLE
- PARALLEL :30 AMP, DOUBLE
- OUTLETS :15 AMP
- MICROWAVE :15 AMP
- BATTERY CHARGER :15 AMP
- WATER HEATER :15 AMP
- AIR CONDITIONER :25 AMP
- SPARE :NONE

BREAKER LIST TO BE SUPPLIED WITH PANEL FOR 230V-50 HERTZ VERSION.

- AC MAIN :15 AMP, DOUBLE
- GENERATOR :30 AMP, DOUBLE
- PARALLEL :15 AMP, DOUBLE
- OUTLETS :10 AMP
- MICROWAVE :10 AMP
- BATTERY CHARGER :10 AMP
- WATER HEATER :10 AMP
- AIR CONDITIONER :15 AMP
- SPARE :NONE

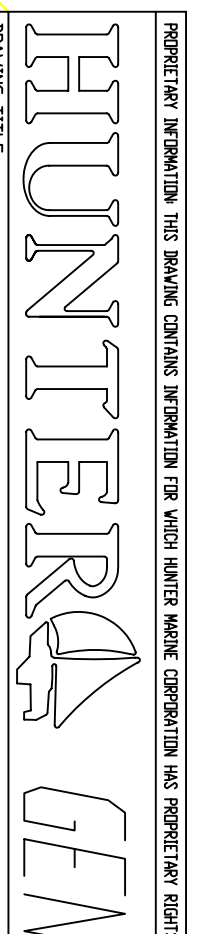
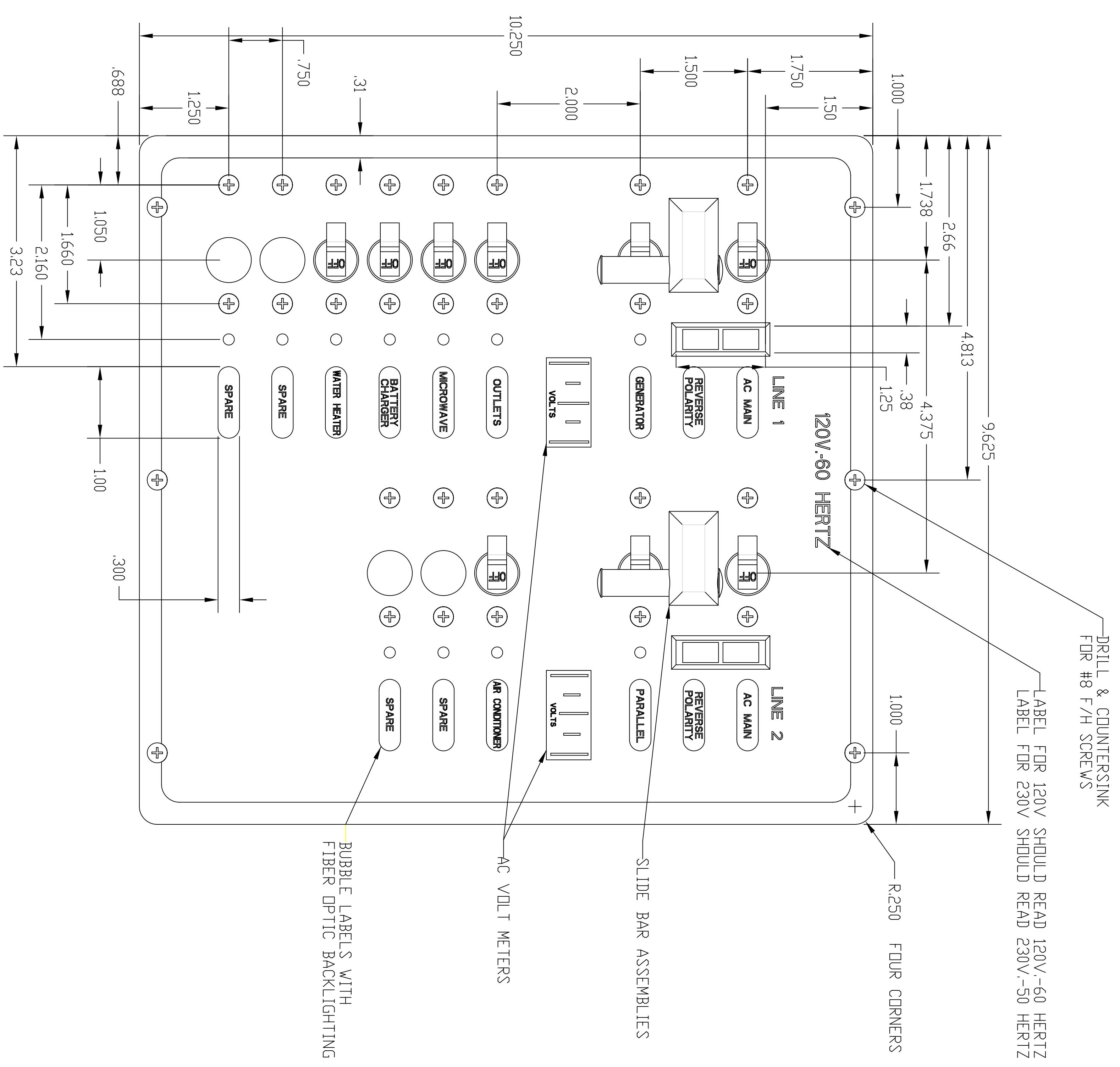

PROPERTY RESERVATION: THE SHARING OF ANY INFORMATION ON THIS DRAWING CONSTITUTES AN IMPLICIT OR EXPLICIT AGREEMENT BY THE USER TO ACCEPT THE TERMS AND CONDITIONS OF THE HUNTER GEM SOFTWARE LICENSE AGREEMENT. HUNTER GEM SOFTWARE LICENSE AGREEMENT: [http://www.huntergem.com/licenses/](#)

ISSUING TITLE: 120/230VAC PANEL WITH AIR AND GENSET
 2004 MODEL YEAR FOR H36

SCALE: 1:1000
 DRAWN BY: JLK
 CHECKED: [Signature]
 DATE: 17-Apr-2003
 SHEET 1 OF 1
 DRAW # 00051003A

LEGEND
 — = 8ga wire
 — = 18-14ga wire
 10ga marked as shown.

NOTE: ALL INDICATOR LIGHTS NEUTRAL WIRES CONNECTS TO EITHER LINE 1 OR LINE 2 NEUTRAL BUS UNLESS SPECIFIED.

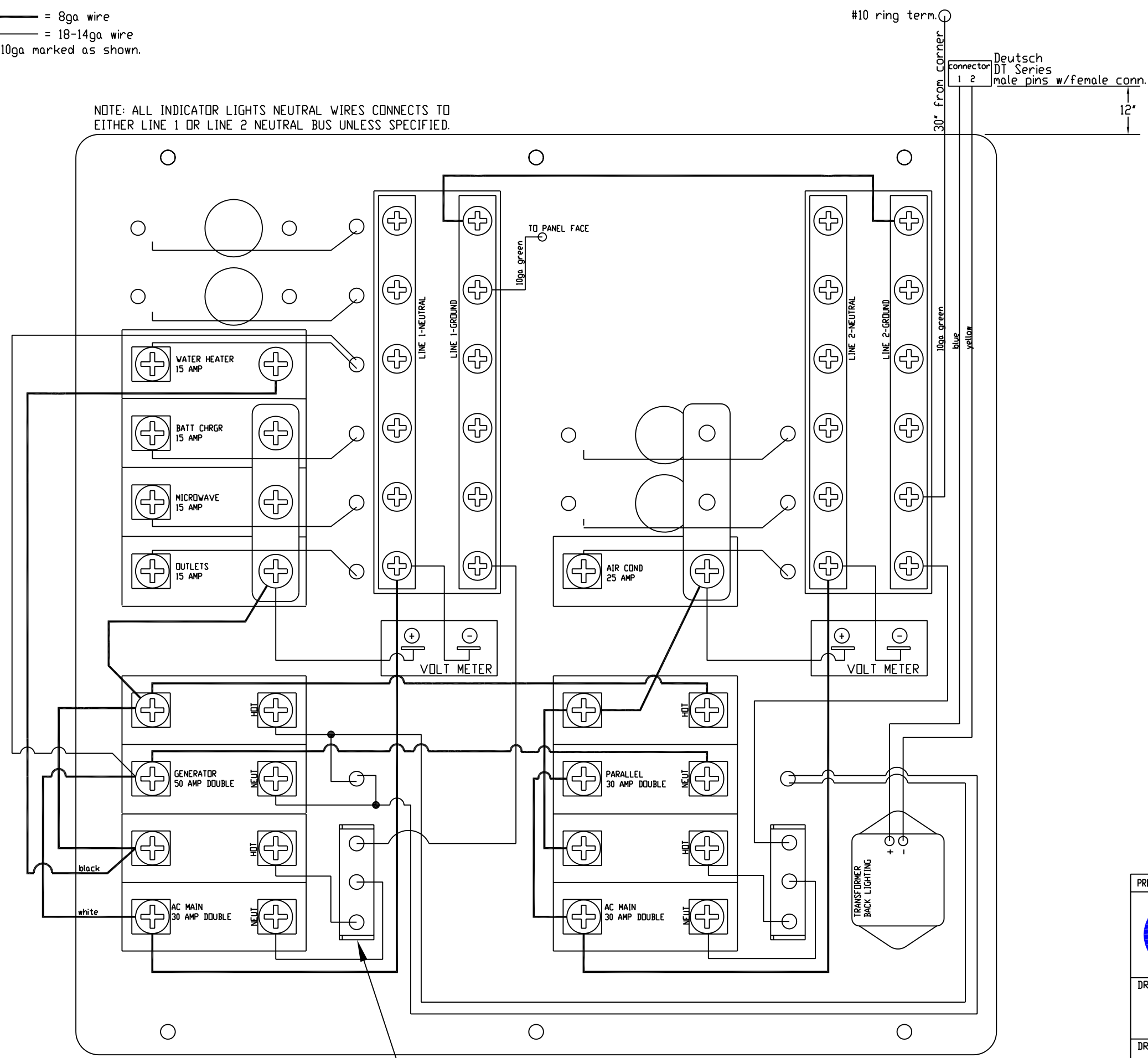

BREAKER LIST FOR 120V PANEL -

- AC MAIN - 30 AMP
- GENERATOR - 50 AMP
- OUTLETS - 15 AMP
- MICROWAVE - 15 AMP
- BATTERY CHARGER - 15 AMP
- WATER HEATER - 15 AMP
- FWD AIR COND. - 25 AMP
- AFT AIR COND. - 20 AMP
- AIR COND. RELAY - 5 AMP

BREAKER LIST FOR 230V PANEL -

- AC MAIN - 15 AMP
- GENERATOR - 30 AMP
- OUTLETS - 10 AMP
- MICROWAVE - 10 AMP
- BATTERY CHARGER - 10 AMP
- WATER HEATER - 10 AMP
- FWD AIR COND. - 15 AMP
- AFT AIR COND. - 10 AMP
- AIR COND. RELAY - 5 AMP

- NOTE:
1. WIRES MUST BE UNIFORM AND TIE-WRAPPED AS NEEDED.
 2. SOME COMPONENTS SHOWN MAY NOT BE EXACT.
 3. ALL DIMINSIONS IF ANY ARE IN INCHES.

SoLiCo 3450-1-20-1934A, for 120V panel
 SoLiCo 3452-1-20-1934A, for 230V panel

PROPRIETARY INFORMATION: THIS DRAWING CONTAINS INFORMATION FOR WHICH HUNTER MARINE CORPORATION HAS PROPRIETARY RIGHTS.



DRAWING TITLE:
DUAL LINE AC PANEL SCHEMATIC

DRAWN BY: JLK	DATE: 18-Dec-03	SHEET 1	OF 1
SCALE: 0.750	HUNTER PART NO. TBD	REVISION -	DRAW # 00051003A-SCH

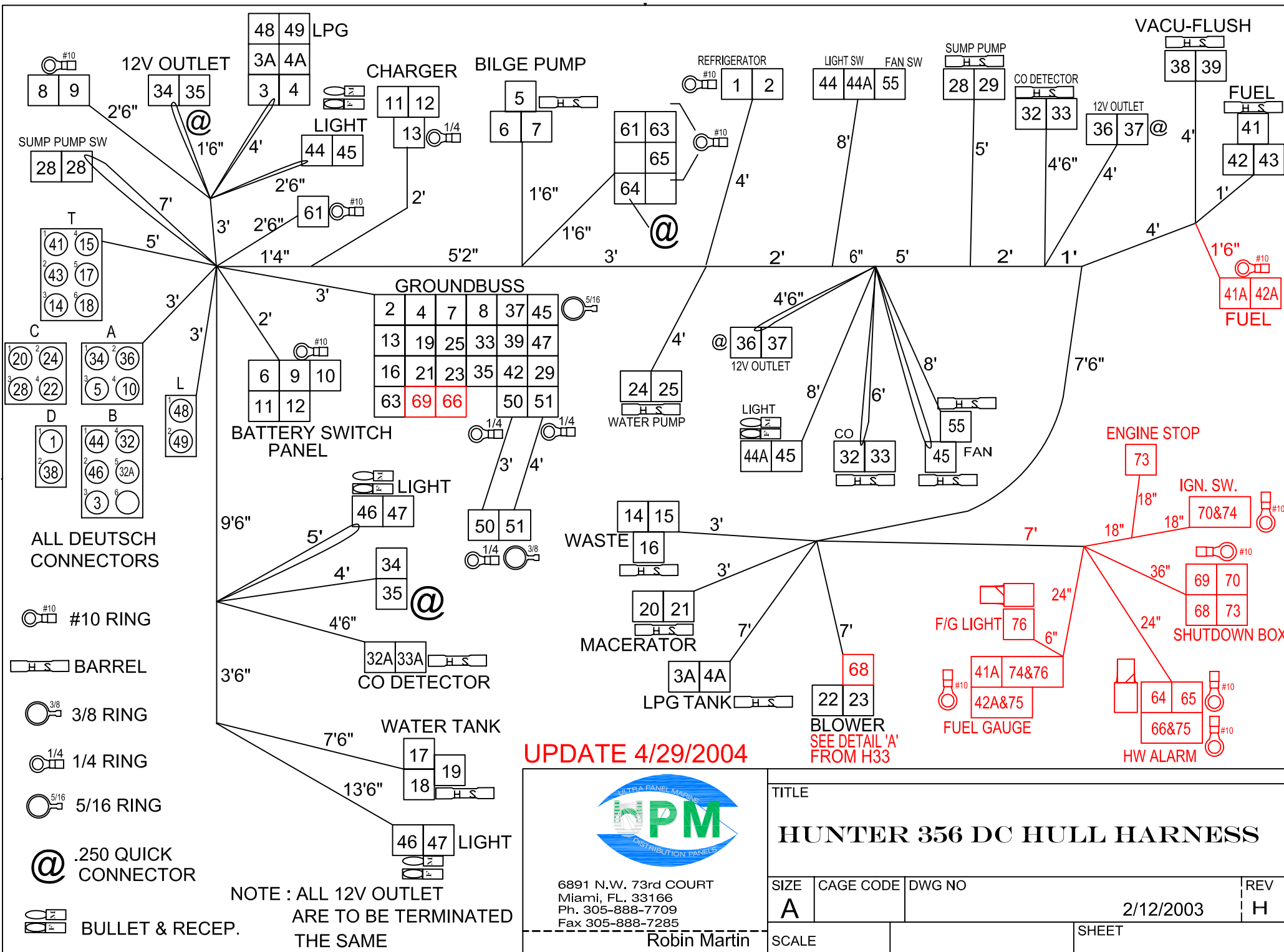

NOTE : ALL 12V OUTLET ARE TO BE TERMINATED THE SAME

UPDATE 4/29/2004



6891 N.W. 73rd COURT
Miami, FL. 33166
Ph. 305-888-7709
Fax 305-888-7285

Robin Martin

TITLE			
HUNTER 356 DC HULL HARNESS			
SIZE	CAGE CODE	DWG NO	REV
A			H
SCALE		SHEET	2/12/2003

HUNTER 36 DC HULL HARNESS

4/29/2004

WIRE#	GAUGE	COLOR	LENGTH	FUNTION
1	10	RED/BLACK	19'	REFRIGERATION
2	10	YELLOW	15'6"	REFRIGERATION GROUND
3	16	ORANGE/RED	9'	LPG
4	16	YELLOW	9'	LPG GROUND
3A	16	ORANGE/GREEN	41'6"	LPG SWITCH
4A	16	YELLOW	41'6"	LPG GROUND
5	12	BROWN/RED	10'	BILGE
6	12	BROWN/ORANGE	10'	BILGE AUTO
7	12	YELLOW	10'	BILGE GROUND
8	6	YELLOW	7'6"	DC GROUND
9	6	ORANGE/RED	7'6"	DC POWER
10	12	TAN	4'	BILGE AUTO POWER
11	8	ORANGE/GREEN	5'4"	BATTERY CHARGER
12	8	ORANGE/RED	5'4"	BATTERY CHARGER
13	8	YELLOW	5'4"	BATTERY CHARGER GROUND
14	16	ORANGE/GREEN	34'6"	WASTE LEVEL IND
15	16	PINK/BLUE	34'6"	WASTE LEVEL IND
16	16	YELLOW	32'6"	WASTE LEVEL IND GROUND
17	16	ORANGE/BLUE	24'6"	WATER LEVEL IND
18	16	PINK/BLACK	24'6"	WATER LEVEL IND
19	16	YELLOW	22'6"	WATER LEVEL IND GROUND
20	10	BROWN/WHITE	30'6"	MACERATOR
21	12	YELLOW	30'6"	MACERATOR GROUND
22	12	BROWN/BLUE	34'6"	BLOWER
23	10	YELLOW	34'6"	BLOWER GROUND
24	12	BROWN	15'6"	WATER PUMP
25	12	YELLOW	15'6"	WATER PUMP GROUND
28	12	BROWN/BLACK	38'	SUMP PUMP
29	12	YELLOW	24'	SUMP PUMP GROUND
32	16	RED/BLUE	35'	CO DETECTOR
33	16	YELLOW	35'	CO DETECTOR GROUND
32A	16	RED/BLUE	16'6"	CO DETECTOR
33A	16	YELLOW	16'6"	CO DETECTOR GROUND
34	12	RED	26'6"	12V OUTLET
35	12	YELLOW	26'6"	12V OUTLET GROUND
36	12	RED	32'6"	12V OUTLET
37	12	YELLOW	32'6"	12V OUTLET GROUND
38	10	BROWN/PINK	30'	VACU-FLUSH
39	10	YELLOW	30'	VACU-FLUSH GROUND
41	16	PINK	29'	FUEL
41A	16	PINK	22'	FUEL SENSOR (S)
42	16	YELLOW	27'	FUEL GROUND
42A	16	YELLOW	22'	FUEL SENSOR (-)
43	16	ORANGE/WHITE	29'	FUEL
44	16	BLUE	21'6"	LIGHT SWITCH
44A	16	BLUE/WHITE	16'6"	DISHRACK LIGHT
45	16	YELLOW	33'	LIGHT GND.
46	16	BLUE	37'6"	LIGHT
47	16	YELLOW	37'6"	LIGHT GND.
48	16	BLUE	9'	LIGHT SWITCH
49	16	BLUE	9'	LIGHT SWITCH
50	6	YELLOW	5'	GND SYSTEM
51	6	YELLOW	4'	GND SYSTEM
55	16	WHITE	16'6"	DISHRACK FAN
61	8	WHITE/GREEN	9'	HW PUMP AUTO
63	8	YELLOW	8'	HW PUMP NEG
64	16	YELLOW/BROWN	26'6"	HW RELAY SW
65	16	BROWN/RED	26'6"	HW ALARM IND
66	16	YELLOW	34'	HW ALARM NEG
68	16	BROWN/BLUE	17'	BLOWER RELAY
69	16	YELLOW	45'6"	FIRE EXT. SHUTDOWN BOX
70	16	RED	6'	IGNITION SWITCH
73	16	WHITE/BROWN	6'	ENGINE STOP
74	16	RED	5'	FUEL GAUGE POWER
75	16	YELLOW	4'	FUEL GAUGE NEGATIVE
76	16	RED	6"	FUEL GAUGE LIGHT

HULL HARNESS CONNECTORS for 36

All connectors to be male connectors.

8/14/03 Rev. A

CONN. A	WIRE# (HULL)	NOTES:	CONN. TYPE
1	#34, 14ga Red, 12V OUTLET		Deutsch - DTP Series - 4 pin
2	#36, 14ga Red, 12V OUTLET		
3	#5, 12ga Brown/Red, BILGE MANUAL		
4	#10, 12ga Tan, BILGE POWER		

CONN. B	WIRE# (HULL)	NOTES:	CONN. TYPE
1	#44, 16ga Blue, CABIN LIGHTS		Deutsch - DT Series - 6 pin
2	#46, 16ga Blue, CABIN LIGHTS		
3	#3, 16ga Orange/Red, LPG		
4	#32, 16ga Red/Blue, CO ALARM		
5	#32A, 16ga Red/Blue, CO ALARM		
6			

CONN. C	WIRE# (HULL)	NOTES:	CONN. TYPE
1	#20, 10ga Brown/White, MACERATOR		Deutsch - DTP Series - 4 pin
2	#24, 12ga Brown, WATER PUMP		
3	#28, 12ga Brown/Black, SUMP PUMP		
4	#22, 12ga Brown/Blue, BLOWER		

CONN. D	WIRE# (HULL)	NOTES:	CONN. TYPE
1	#1, 10ga Red/Black, REFRIGERATOR		Deutsch - DTP Series - 2 pin
2	#38, 10ga Brown/Pink, ELECTRIC TOILET		

CONN. L	WIRE# (TO DECK)	NOTES:	CONN. TYPE
1	#48, 16ga blue, LIGHT SWITCH LOOP		Deutsch - DT Series - 2 pin
2	#49, 16ga blue, LIGHT SWITCH LOOP		

CONN. T	WIRE# (HULL)	NOTES:	CONN. TYPE
1	#41, 16ga Pink, FUEL SENSOR (S)		Deutsch - DT Series - 6 pin
2	#43, 16ga Orange/White, FUEL SENSOR (+)		
3	#14, 16ga Orange/Green, WASTE SENSOR (+)		
4	#15, 16ga Pink/Gray, WASTE SENSOR (S)		
5	#17, 16ga Orange/Blue, WATER SENSOR (+)		
6	#18, 16ga Pink/Black, WATER SENSOR (s)		

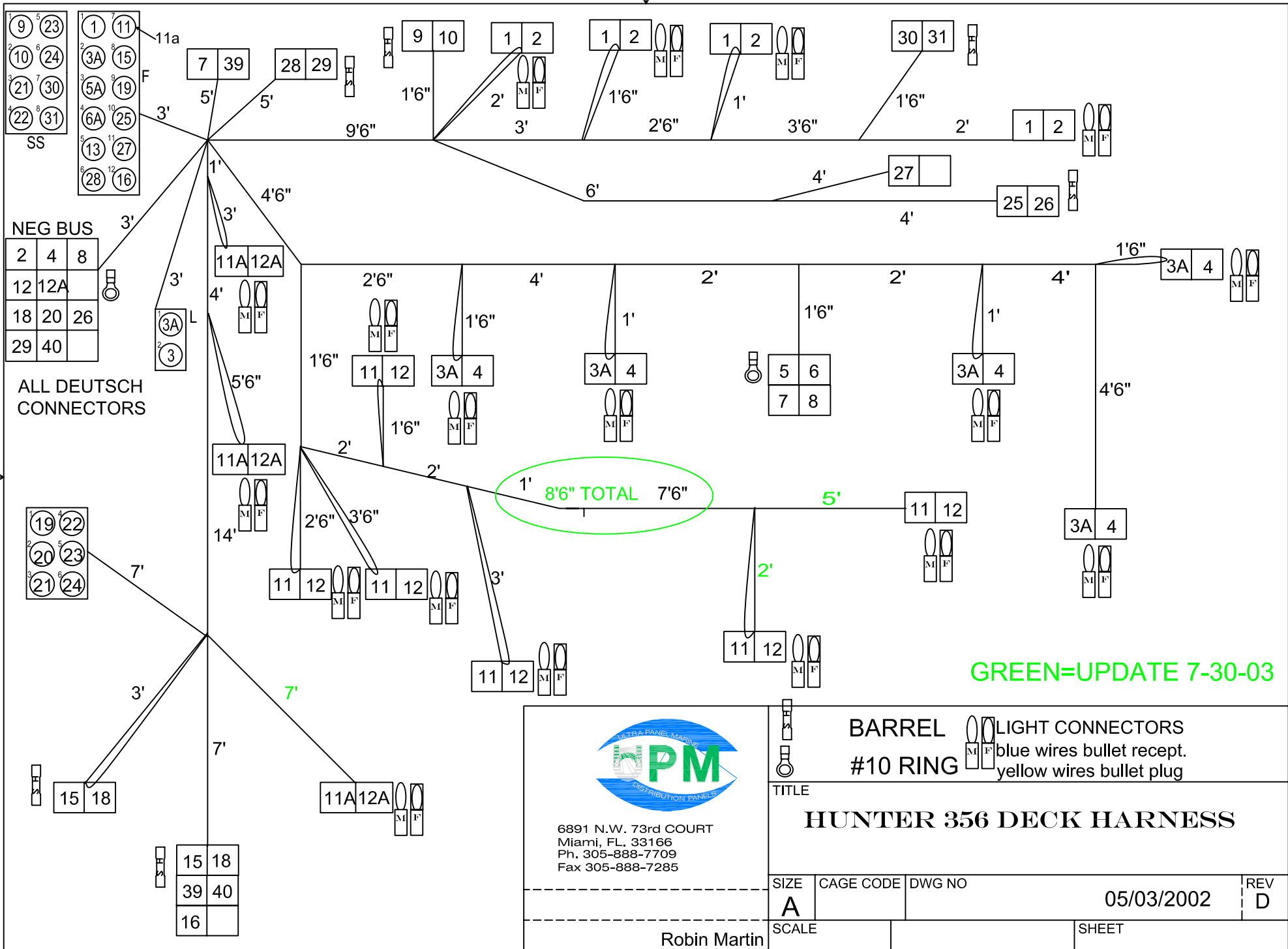

GREEN=UPDATE 7-30-03



6891 N.W. 73rd COURT
 Miami, FL. 33166
 Ph. 305-888-7709
 Fax 305-888-7285

Robin Martin

BARREL LIGHT CONNECTORS
 #10 RING blue wires bullet recept.
 yellow wires bullet plug

TITLE
HUNTER 356 DECK HARNESS

SIZE A	CAGE CODE	DWG NO	REV D
SCALE	SHEET		05/03/2002

WIRE#	GAUGE	COLOR	LENGTH	FUNCTION
1	16	BLUE	35'	CABIN LIGHTS
2	16	YELLOW	35'	CABIN LIGHTS GROUND
3	16	BLUE	6'	CABIN LIGHTS
3A	16	BLUE	34'6"	SWITCH POWER
4	16	YELLOW	34'6"	CABIN LIGHTS
5	14	GRAY\RED	17'	ANCHOR LIGHT
6	14	GRAY\GREEN	17'	STEAMING LIGHT
7	16	GRAY	17'	DECKING LIGHT
8	10	YELLOW	17'	NAV LIGHT GROUND
9	16	WHITE\ORANGE	14'	PORT MAIN SPEAKER
10	16	WHITE\YELLOW	14'	PORT MAIN SPEAKER GROUND
11	16	BLUE	48'	CABIN LIGHTS
11A	16	BLUE	38'	CABIN LIGHTS
12	16	YELLOW	48'	CABIN LIGHTS GROUND
12A	16	YELLOW	38'	CABIN LIGHTS GROUND
15	16	GRAY\YELLOW	35'	STERN LIGHT
16	16	RED\BLACK	29'	GPS
18	16	YELLOW	35'	STERN LIGHT GROUND
19	16	BLUE\WHITE	29'	ARCH LIGHT
20	16	YELLOW	29'	ARCH LIGHT GROUND
21	16	WHITE\PINK	29'	PORT ARCH SPEAKER
22	16	WHITE\YELLOW	29'	PORT ARCH SPEAKER GROUND
23	16	WHITE\GRAY	29'	STBD ARCH SPEAKER
24	16	WHITE\BLACK	29'	STBD ARCH SPEAKER GROUND
25	16	GRAY\WHITE	22'6"	BOW LIGHT
26	16	YELLOW	22'6"	BOW LIGHT GROUND
27	16	TAN	20'6"	
28	16	RED\WHITE	8'	VHF POWER
29	16	YELLOW	8'	VHF GROUND
30	16	WHITE\BLUE	23'	STBD MAIN SPEAKER
31	16	WHITE\BLACK	23'	STBD MAIN SPEAKER GROUND
39	10	RED	29'	AUTO PILOT
40	10	YELLOW	29'	AUTO PILOT GROUND

DECK HARNESS CONNECTORS for 36

All connectors to be male connectors.

8/14/03 Rev. A

CONN. F	WIRE# (DECK)	NOTES:	CONN. TYPE
1	#1, 16ga blue, MAIN LIGHTS		Deutsch - DT Series - 12 pin
2	#3A, 16ga blue, FORWARD LIGHTS		
3	#5A, 16ga gray/red, ANCHOR LIGHT		
4	#6A, 16ga gray/green, STEAMING LIGHT		
5	#13, 16ga blue, PORT AFT LIGHTS		
6	#28A, 16ga red/white, VHF PWR		
7	#11, 16ga blue, STBD LIGHTS		
8	#15, 16ga gray/yellow, STERN LIGHT		
9	#19, 16ga blue/white, ARCH LIGHT		
10	#25, 16ga gray/white, BOW LIGHT		
11	#27, 16ga tan, WINDLASS		
12	#16, 16ga red/black, GPS		

CONN. SS	WIRE# (TO STEREO)		CONN. TYPE
1	#9, 16ga white/orange, PORT MAIN SPEAKER (+)		Deutsch - DT Series - 8 pin
2	#10, 16ga white/yellow, PORT MAIN SPEAKER (-)		
3	#21, 16ga white/pink, PORT ARCH SPEAKER (+)		
4	#22, 16ga white/yellow, PORT ARCH SPEAKER (-)		
5	#23, 16ga white/gray, STBD ARCH SPEAKER (+)		
6	#24, 16ga white/black, STBD ARCH SPEAKER (-)		
7	#30, 16ga white/blue, STBD MAIN SPEAKER (+)		
8	#31, 16ga white/black, STBD MAIN SPEAKER (-)		

CONN. L	WIRE# (TO HULL)		CONN. TYPE
1	#3A, 16ga blue, LIGHT SWITCH LOOP		Deutsch - DT Series - 2 pin
2	#3, 16ga blue, LIGHT SWITCH LOOP		

CONN. Arch	WIRE# (TO ARCH)		CONN. TYPE
1	#19, 16ga blue/white, ARCH LIGHT		Deutsch - DT Series - 6 pin
2	#20, 16ga yellow, ARCH LIGHT (-)		
3	#21, 16ga white/pink, PORT ARCH SPEAKER (+)		
4	#22, 16ga white/yellow, PORT ARCH SPEAKER (-)		
5	#23, 16ga white/gray, STBD ARCH SPEAKER (+)		
6	#24, 16ga white/black, STBD ARCH SPEAKER (-)		

No Connector	WIRE# (to spare on panel)	NOTE:	
	#39, 10ga red, AUTOPILOT	Make 2' longer than connectors starting point.	
	#7, 16ga gray, DECK LIGHT		

36, P/N 1007558
DECK RIGGING STAGE 34

REVISION
 A: 02-19-03
 B: 06-10-03
 C: 07-23-03
 D: 11-16-05

DECKRIGGING

1 8'



2



5 4'



6



3 18'



4 10'



7 2.5'



8 9'



#	EYE	SIZE	EYE	COLOR	LENGTH	DESCRIPTION
1		16 GA		BLUE	8'	VANITY LIGHT
2		16 GA		YELLOW	8'	VANITY LIGHT GROUND
3		RG213/U		COAX	18'	VHF CABLE
4		10-3		ROMEX	10'	SHORE POWER 1
5		16 GA		RED	4'	SHUTDOWN POWER
6		16 GA		YELLOW	4'	SHUTDOWN NEGATIVE
7		16 GA		WHITE/BROWN	2.5'	SHUTDOWN BYPASS
8		6 GA		GREEN/ YELLOW	9'	PEDESTAL GND

MODULE STAGE 24A 110 VOLT HARNESS, P/N 1007561

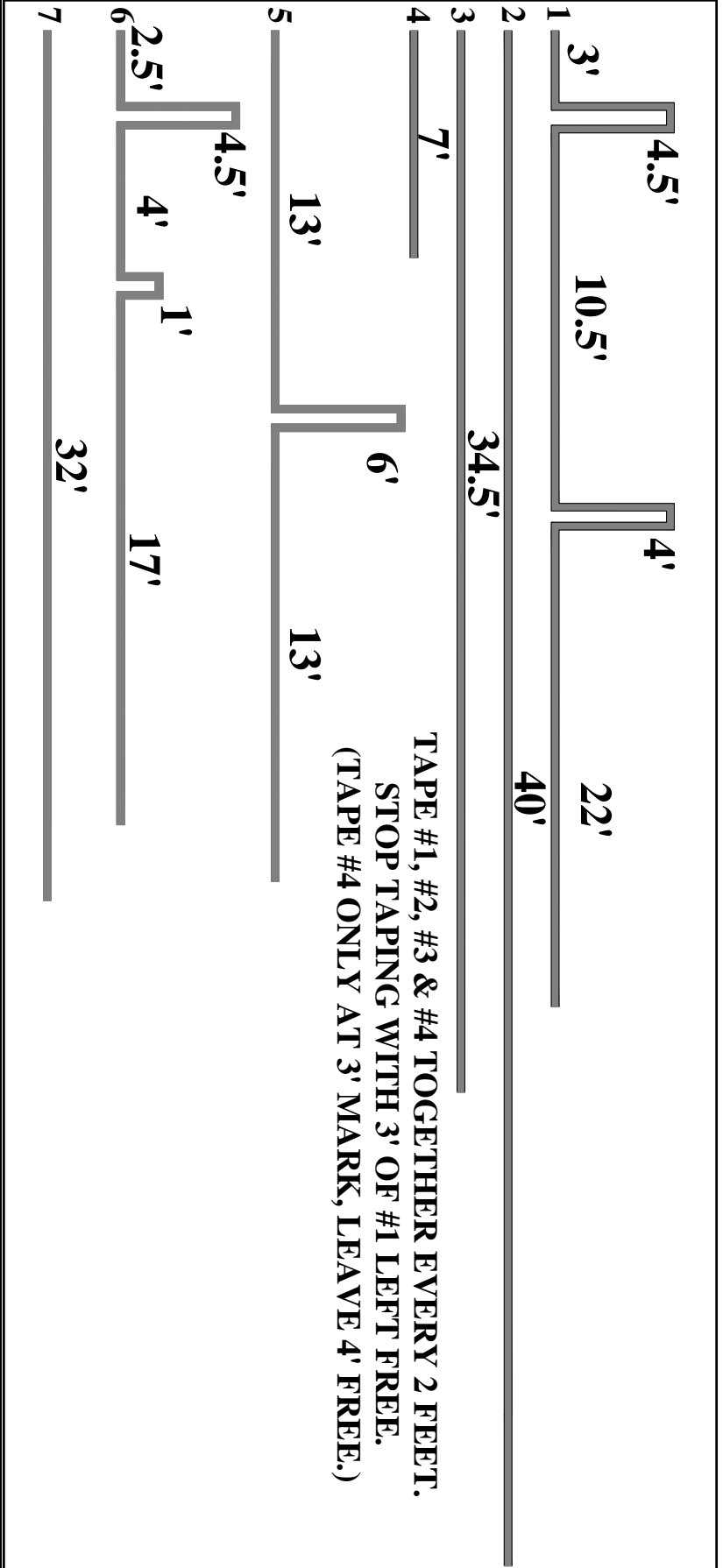

#	SIZE	COLOR	LENGTH	DESCRIPTION
1	14-3	ROMEX	52.5'	STARBOARD FORWARD OUTLETS
2	14-3	ROMEX	40'	WATER HEATER
3	14-3	ROMEX	34.5'	MICROWAVE
4	14-3	ROMEX	7'	BATTERY CHARGER
5	14-3	ROMEX	38'	STBD AFT. OUTLETS
6	14-3	ROMEX	34.5'	PORT OUTLETS
7	10-3	ROMEX	32'	TRANSFORMER 1

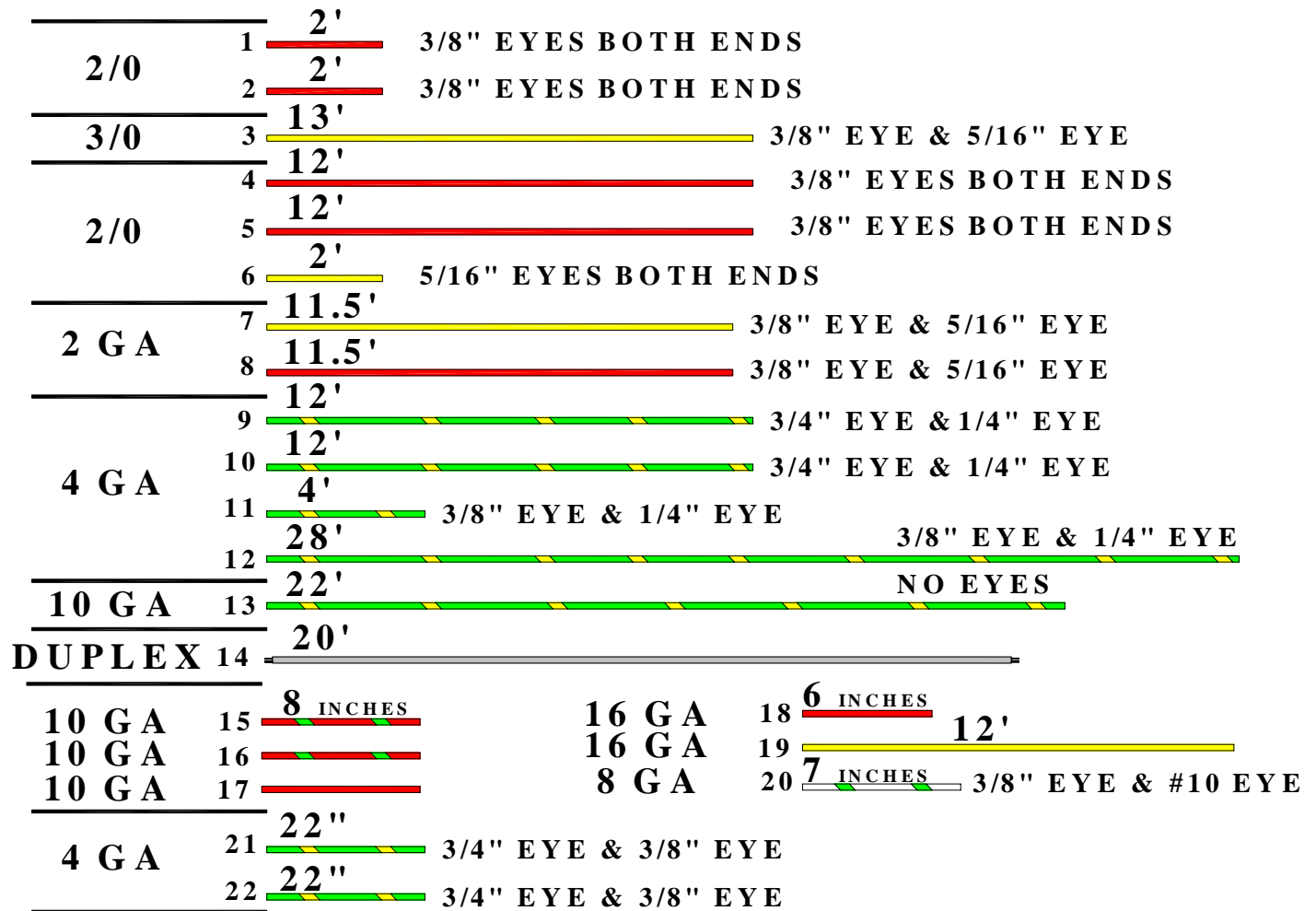

#	SIZE	COLOR	LENGTH	DESCRIPTION
1	2/0	RED	2'	#1 BATTERY POSITIVE JUMPER
2	2/0	RED	2'	#2 BATTERY POSITIVE JUMPER
3	3/0	YELLOW	13'	BATTERY NEGATIVE
4	2/0	RED	12'	#1 BATTERY POSITIVE
5	2/0	RED	12'	#2 BATTERY POSITIVE
6	2/0	YELLOW	2'	BATTERY NEGATIVE JUMPER
7	2 GA	YELLOW	11.5'	ENGINE NEGATIVE
8	2 GA	RED	11.5'	ENGINE POSITIVE
9	4 GA	GREEN/YELLOW	12'	PORT CHAINPLATE GROUND
10	4 GA	GREEN/YELLOW	12'	STBD. CHAINPLATE GROUND
11	4 GA	GREEN/YELLOW	4'	MAST POST GROUND
12	4 GA	GREEN/YELLOW	28'	RADAR ARCH GROUND
13	10 GA	GREEN/YELLOW	22'	FUEL FILL GROUND
14	DUPLEX	WHITE	20'	FIRE EXTINGUISHER
15	10 GA	RED/GREEN	8 INCHES	HW RELAY JUMPERS
16	10 GA	RED/GREEN	8 INCHES	HW RELAY JUMPERS
17	10 GA	RED	8 INCHES	HW RELAY JUMPERS
18	16 GA	RED	6 INCHES	BLOWER RELAY
19	16 GA	YELLOW	12'	BLOWER RELAY GROUND
20	8 GA	WHITE/GREEN	7 INCHES	HW RESET JUMPER
21	4 GA	GREEN/YELLOW	22"	PORT INNER CHAINPLATE GND
22	4 GA	GREEN/YELLOW	22"	STBD INNER CHAINPLATE GND

MODULE STAGE 24A

WINDLASS

P/N 1002508

- 1 1.5' (2 GA) 5/16" EYE & 5/16" EYE
- 2 1.5' (2 GA) 5/16" EYE & 5/16" EYE
- 3 1.5' (2 GA) 3/8" EYE & 1/4" EYE
- 4 24' (2 GA) 1/4" EYE & 5/16" EYE
- 5 24' (2 GA) 5/16" EYE & 5/16" EYE
- 6 1.5' (16 GA) 5/16" EYE & FEMALE SPADE

NUMBER	SIZE	COLOR	LENGTH	DESCRIPTION
1	2 GA	RED	1.5'	WINDLASS JUMP
2	2 GA	RED	1.5'	WINDLASS JUMP
3	2 GA	RED	1.5'	WINDLASS JUMP
4	2 GA	RED	24'	WINDLASS
5	2 GA	YELLOW	24'	WINDLASS
6	16 GA	YELLOW	1.5'	CONTROL BOX NEG.

AIR CONDITIONING

P/N 1007562

- 1 7' (14-3)
- 2 18.5' (10-3)
- 3 32' (10-3)
- 4 10' (10-3)

NUMBER	SIZE	COLOR	LENGTH	DESCRIPTION
1	14-3	ROMEX	7'	AIR CONDITIONING WATER PUMP
2	10-3	ROMEX	18.5'	AIR CONDITIONING
3	10-3	ROMEX	32'	TRANSFORMER 2
4	10-3	ROMEX	10'	SHORE POWER 2

GENERATOR, PANDA 4200





- 1 22' (10-3)
- 2 6' (2GA) 3/8" EYE & 3/8" EYE
- 3 6 1/2' (2GA) 3/8" EYE & 5/16" EYE
- 4 5' (2GA) 3/8" EYE & 5/16" EYE

NUMBER	SIZE	COLOR	LENGTH	DESCRIPTION
1	10-3	ROMEX	22'	GENERATOR
2	2 GA	RED	6'	GENERATOR STARTER
3	2 GA	YELLOW	6 1/2'	GENERATOR GROUND
4	2 GA	RED	5'	BATTERY TO SAFETY SWITCH

MODULE STAGE 24A

INVERTER







P/N 1007560

- 1  **4'** (1/0) **5/16" EYE & 1/4"**
- 2  **6'** (10-3)
- 3  **6'** (10-3)
- 4  **2'6"** (2/0) **3/8" EYE & 3/8" EYE**
- 5  **5'** (2/0) **3/8" EYE & 3/8" EYE**
- 6  **1'6"** (2/0) **3/8" EYE & 3/8" EYE**

NUMBER	SIZE	COLOR	LENGTH	DESCRIPTION
1	1/0	YELLOW/GREEN	4'	INVERTER GROUND
2	10-3	ROMEX	6'	INVERTER IN
3	10-3	ROMEX	6'	INVERTER OUT
4	2/0	RED	2'6"	INVERTER JUMP
5	2/0	YELLOW	5'	INVERTER JUMP
6	2/0	RED	1'6"	INV TO FUSE

ELECTRIC HALYARD

P/N 293895

- 1  **4'** (2/0) **3/8" EYE & 5/16" EYE**
- 2  **2'** (2 GA) **5/16" EYE & 5/16" EYE**
- 3  **2'** (2 GA) **5/16" EYE & 5/16" EYE**
- 4  **1'** (2 GA) **3/8" EYE & 1/4" EYE**
- 5  **22'** (2 GA) **1/4" EYE & 5/16" EYE**
- 6  **22'** (2 GA) **5/16" EYE & 5/16" EYE**

NUMBER	SIZE	COLOR	LENGTH	DESCRIPTION
1	2/0	RED	4'	HALYARD SELECTION-STUD JUMP
2	2 GA	RED	2'	HALYARD MOTOR JUMP
3	2 GA	RED	2'	HALYARD MOTOR JUMP
4	2 GA	RED	1'	HALYARD SELECTION-BREAKER JUMP
5	2 GA	RED	22'	BATTERY POWER FEED
6	2 GA	YELLOW	22'	BATTERY GROUND

DECK RIGGING STAGE 34

TV/DVD

P/N 1007565

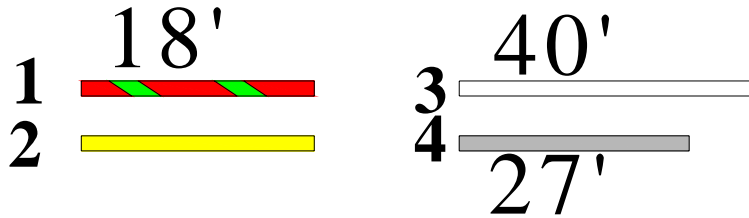

#	EYE	SIZE	EYE	COLOR	LENGTH	DESCRIPTION
1		12 GA		RED/GREEN	18'	TV/DVD PWR
2		12 GA		YELLOW	18'	TV/DVD NEG.
3		RG59		COAX	40'	TV CABLE
4		22 GA		4 COND.	27'	PHONE CABLE

P/N 1007566

F R E E Z E R

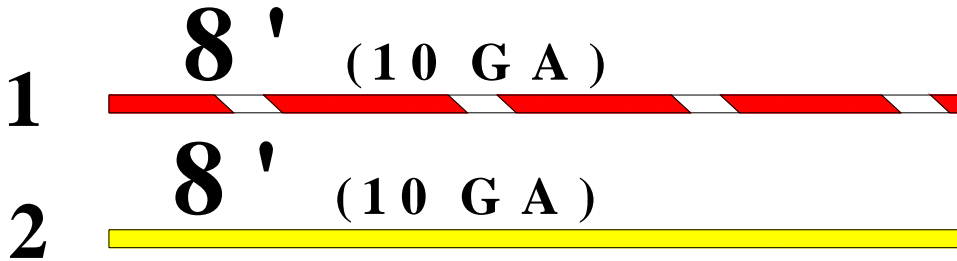

#	EYE	SIZE	EYE	COLOR	LENGTH	DESCRIPTION
1		10 GA		RED/WHITE	8'	FREEZER PWR
2		10 GA		RED	8'	FREEZER NEG

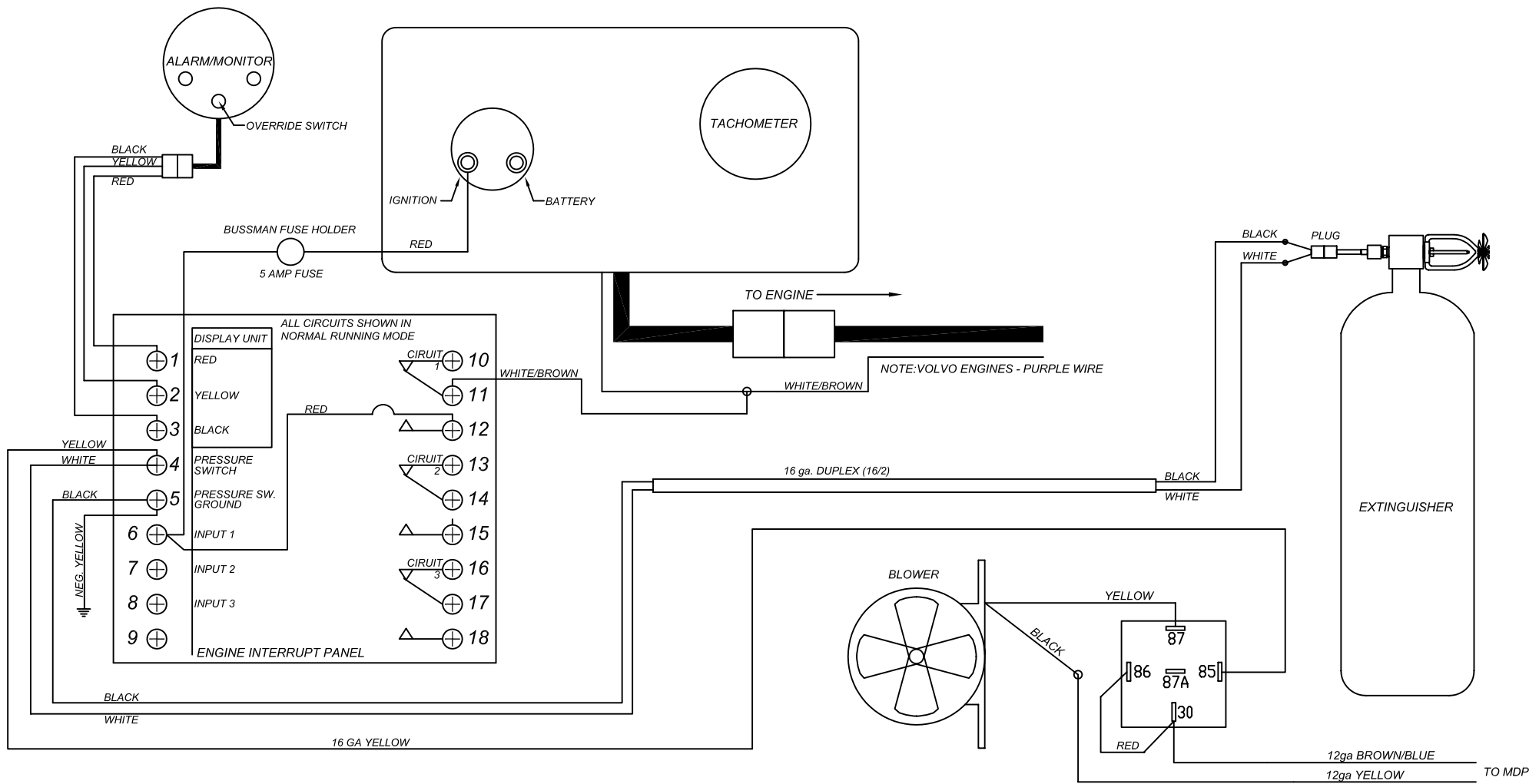

PROPRIETARY INFORMATION THIS DRAWING CONTAINS INFORMATION FOR WHICH HUNTER MARINE CORPORATION HAS PROPRIETARY RIGHTS.

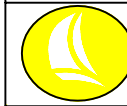

HUNTER 306/326/36

DRAWING TITLE: AUTOMATIC FIRE EXTINGUISHER SCHEMATIC				
DRAWN BY: JLK	DATE: 30-Jan-04	SHEET 1	OF 1	
SCALE: 0.045	HUNTER PART NO. TBD	REVISION B	DRAW # -----	

CHECKED

